

Aztec 600 MANUAL

JUNHO 2013

Aztec 600 aluminium, ammonia, color, iron, manganese,
phosphate
Single- and multi-stream colorimetric analyzers



The Company

We are an established world force in the design and manufacture of measurement products for industrial process control, flow measurement, gas and liquid analysis and environmental applications.

As a part of ABB, a world leader in process automation technology, we offer customers application expertise, service and support worldwide.

We are committed to teamwork, high quality manufacturing, advanced technology and unrivalled service and support.

The quality, accuracy and performance of the Company's products result from over 100 years experience, combined with a continuous program of innovative design and development to incorporate the latest technology.

Configuration Level

- see section 6, page 24
- see section 7, page 42
- see section 8, page 49
- see section 11, page 55
- see section 12.2, page 61
- see section 3.2, page 11
- see section 9, page 51
- see section 10, page 52

Chart View Menu – see Section 2.1 **Indicator View Menu – see Section 2.1**

Configuration Operator 1

- Logging Operator 2 (No access)
- Operator 3 (No access)
- Operator 4 (No access)
- Chart Function
- Statistics
- Alarm Acknowledge
- Help

Configuration Operator 1

- Logging Operator 2 (No access)
- Operator 3 (No access)
- Operator 4 (No access)
- Operate
- Diagnostics
- Alarm Acknowledge
- Help

Operator 1 - Password (0..9999)

7 8 9

4 5 6

1 2 3 C

0 Del OK

Operator 1

Edit Current Configuration

Open a Configuration

New Configuration

Cancel

System Configuration

- Common
- Measurement
- Calibration
- Alarm Relays
- Current Outputs
- Logging
- Communications
- Help
- Exit

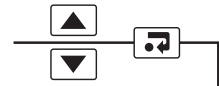

Common Configuration – see Section 6.1

- Common Measurement
- Calibration
- Alarm Relays
- Current Outputs
- Logging
- Communications
- Help
- Exit

Common Configuration

Setup Screen Time Security User --->

Language English

Instrument tag Iron Monitor

Main View Timer 1 minutes

Common Configuration

Setup Screen Time Security User --->

Screen saver wait time Disabled

Screen Capture Disabled

Brightness 60

Common Configuration

Setup Screen Time Security User --->

Date and time 19/08/08 15:57:20

Daylight Saving - Enable Auto - Europe

Daylight Saving - Start 2:00, Last Su - Mar

Daylight Saving - End 3:00, Last Su - Oct

Common Configuration

Setup Screen Time Security User --->

Security type Advanced, Password...

Operator level security On

Reconfigure preset No

Password expiry Disabled

Inactive user disabling Off

Password failure limit Infinite

Min password length 4 characters

Common Configuration

Setup Screen Time Security User --->

User 1 Name Operator 1

User 1 Access Config (Full), Login...

User 1 Password ****

View/Edit Other Users Off

Common Configuration

Op. Messages 1..6 7..12 13..18 19..24

Message 1

Message 2

Message 3

Message 4

Message 5

Message 6

Measurement – see Section 6.2

Measurement

Setup Streams Clean

Measurement Rate 6 / hour

Chemical Units Fe

Measuring Units mg/l

Temperature Units °C

Cell Temperature 35 °C

Stream Sequence 123

Cell Rinse Sequences 2

Measurement

Setup Streams Clean

Stream 1 Stream 1

Stream 1 setup 0.000-7.500;DF=1:0

Stream 2 Stream 2

Stream 2 setup 0.000-7.500;DF=1:0

Stream 3 Stream 3

Stream 3 setup 0.000-7.500;DF=1:0

Measurement

Setup Streams Clean

Cleaning Mode Measure

Port Reagent 1

Cell/Sample Lines Cell & Sample Lines

Cleaning Frequency 1 Hours

Calibration – see Section 6.3

Calibration Settings

Setup

Calibration Time 00:10

Calibration Date 13/08/2008

Calibration Frequency 6 Hours

Low Standard 0.00mg/l

High Standard 0.20mg/l

Gradient Coefficient 1.60

Calibration Fail Event Attention

Alarm Relays – see Section 6.4

Alarm Relays

Alarm A Alarm B Alarm C Alarm D Alarm E Alarm F

Alarm Source Stream 1

Alarm type None

Alarm tag Alarm A

Trip 0.000 mg/l

Hysteresis 0.000 mg/l 0 Secs

Fall Safe Yes

Log enable On

Current Outputs – see Section 6.5

Current Outputs

Out 1 Out 2 Out 3 Out 4 Out 5 Out 6 O/P Cal.

Output Source Stream 1

Output Range 0.00 to 1000.00 mg/l

Output Type 4.00 to 20.00 mA

Calibration Hold No

Out of Sample Ind. Yes

Default Output 22.00 mA

Current Outputs

Out 1 Out 2 Out 3 Out 4 Out 5 Out 6 O/P Cal.

Calibrate Output 1 Calibration Completed

Calibrate Output 2 Start Calibration?

Calibrate Output 3 Start Calibration?

Calibrate Output 4 Start Calibration?

Calibrate Output 5 Start Calibration?

Calibrate Output 6 Start Calibration?

Logging – see Section 6.6

Logging

Chart Ranges Archive

Chart view enable Vertical

Chart annotation None

Chart divisions 5/2

Trace pointers Enabled

Screen interval 1 hour/screen

Trace width 1

Logging

Chart Ranges Archive

Stream 1 0.000-2.000

Stream 2 0.000-2.000

Stream 3 0.000-2.000

Logging

Chart Ranges Archive

Archive file format Text format

Archive file enables *.d, *.e, *.a

New file interval Daily

Wrap Off

Logging* – see section 7, page 42

Configuration

Logging

Chart Functions

Statistics

Alarm Acknowledge

Help

Operator 1

Operator 2

Operator 3

Operator 4

Reset Archiving

Online

Offline

File Viewer

Help

Internal

External

Online Help

Startup Guide

Communications – see Section 6.7

Communications

Ethernet email 1 email 2 Profibus

IP-address 10.44.211.49

Subnet mask 255.255.255.0

Default Gateway 10.44.211.1

FTP user 1 MARTIN

FTP user 2

FTP user 3

FTP user 4

Communications

Ethernet email 1 email 2 Profibus

SMTP Server IP address 172.16.1.1

Recipient 1

Recipient 2

Recipient 3

Inverted Triggers XXXXX

Trigger 1-5 XXXXX

Trigger 6-10 XXXXX

Communications

Ethernet email 1 email 2 Profibus

Slave Address 6

*Chart View Menu shown – logging options from this top level menu cannot be accessed from 'Configuration /Logging'

Contents

1	Safety	3	6	Configuration	24
1.1	Health & Safety	3	6.1	Common	26
1.2	Electrical Safety – CEI/IEC 61010-1:2001-2	3	6.1.1	Setup	26
1.3	Symbols – CEI/IEC 61010-1:2001-2	4	6.1.2	Screen	26
1.4	Product Recycling Information	5	6.1.3	Time	27
1.5	Product Disposal	5	6.1.4	Security	28
1.6	Restriction of Hazardous Substances (RoHS)	5	6.1.5	User	31
1.7	Chemical Reagents	5	6.1.6	Operator Messages	31
1.8	Safety Precautions	5	6.2	Measurement	32
1.9	Safety Conventions	6	6.2.1	Setup	32
1.10	Safety Recommendations	6	6.2.2	Streams	32
1.11	Service and Repairs	6	6.2.3	Clean	32
1.12	Potential Safety Hazards	6	6.3	Calibration	33
			6.3.1	Setup	33
2	Introduction	7	6.3.2	Zero Compensation (Aztec 600 Color only)	33
2.1	Operator Display Overview	8	6.4	Alarm Relays	34
3	Getting Started	10	6.5	Current Outputs	36
3.1	Overview	10	6.5.1	Outputs 1 to 6	36
3.2	On-line Help	11	6.5.2	Output Calibration	36
4	Installation	12	6.6	Logging	37
4.1	Optional Accessories	12	6.6.1	Chart	37
4.2	Sampling Requirements	12	6.6.2	Ranges	37
4.3	Location	12	6.6.3	Archive	38
4.4	Mounting	13	6.7	Communications	39
4.4.1	Reagent Mounting Tray (Option)	13	6.7.1	Ethernet	39
4.5	Dimensions	14	6.7.2	E-mail 1 and E-mail 2	40
4.6	Electrical Connections	15	6.7.3	Profibus	40
4.6.1	Access to Connections	16	6.8	Commissioning	41
4.6.2	Ethernet Connections	17	6.8.1	Setup	41
4.6.3	Connections Overview	18	7	Logging	42
4.6.4	Replacing the DC Fuse	19	7.1	SD Cards	43
4.6.5	Alarm Relay Contact Protection and Interference Suppression	19	7.1.1	SD Card Insertion/Removal	43
4.7	Connecting Sample and Reagents	20	7.1.2	External Media Status Icons	44
4.7.1	Connecting Sample Inlet and Drain Line(s)	20	7.2	Reset Archiving	44
4.7.2	Installing Reagents and Reagent Level Sensors	21	7.3	File Viewer	44
4.7.3	Connecting the Analyzer Waste	21	7.4	Archive File Types	44
5	Operation	22	7.5	Text Format Data Files	45
5.1	Front Panel Controls	22	7.5.1	Text Format Stream Data Filenames	46
5.2	Navigation and Editing	22	7.5.2	Text Format Stream Data – Example Filenames	46
5.2.1	Text Editing	22	7.5.3	Text Format Log Files (Audit and Alarm Log)	47
5.2.2	Numeric Editing	23	7.5.4	Daylight Saving	47
5.2.3	Other Methods of Editing	23	7.5.5	Text Format Data Verification and Integrity	47
5.2.4	Menus	23	7.6	Binary Format Data Files	47
5.3	Software Screen Structure	23	7.6.1	Binary Format Data Filenames	47
5.3.1	Indicator View Menus	23	7.6.2	Binary Format Stream Files	48
5.3.2	Chart View Menus	23	7.6.3	Binary Format Log Files	48
			7.6.4	Daylight Saving	48
			7.6.5	Binary Format Data Verification and Integrity	48

8 Chart Functions	49	Appendix B – Troubleshooting	79
8.1 Historical Review	49	B.1 Analyzer Malfunction	79
8.2 Operator Messages	49	B.2 Cell Diagnostics	79
8.3 Chart Annotation	49	B.3 Effects of Loss of Power to the Analyzer	79
8.4 Screen Interval	50	B.4 Simple Checks	80
8.5 Scales	50	B.4.1 Unstable or Erratic Readings	80
8.6 Trace Select	50	B.4.2 High/Low Measured Values	82
9 Operate	51	B.4.3 Excessive Usage of Reagent(s)	83
9.1 Stop Monitor	51	B.4.4 Calibration Failure	84
9.2 Start Monitor Measurement	51	Appendix C – Principle of Operation	85
9.3 Calibrate	51	C.1 General Operation	85
9.4 Prime Lines and Calibrate	51	C.2 Temperature Control	86
9.5 Flush Monitor	51	C.3 Measurement Cycle	86
10 Diagnostics	52	C.4 Calibration Cycle	86
10.1 Monitor Status	52	C.5 LED Calibration	86
10.1.1 Status	52	C.6 Dilution Cycle	86
10.1.2 Cal	53	C.7 Chemical Measurement Methods Used	87
10.1.3 I/O	53	C.8 Typical Analyzer Calibration Data	89
10.1.4 Info	53	Appendix D – Web Server	90
10.2 Cell Diagnostics	54	D.1 Stream Values	90
10.3 Relay Test	54	D.2 Operate	91
10.4 Current Output Test	54	D.3 Monitor Status	91
11 Statistics	55	D.4 Statistics	91
12 Diagnostic Information and Icons	56	D.5 Logging Status	91
12.1 Analyzer Diagnostic Information	56	D.6 Operator Message	91
12.2 Alarm Acknowledge	61	D.7 Configuration	92
12.3 Audit Log and Alarm Event Log	61	D.8 FTP Access	92
12.3.1 Audit Log – Icons	61	D.9 FTP Access via Internet Explorer	92
12.3.2 Alarm Event Log – Icons	62	D.10 FTP Access via DataManager	93
12.3.3 Status Icons	62	D.11 File Transfer Program	93
13 Maintenance	63	Appendix E – Updating the Software	94
13.1 Changing Reagents	63	Appendix F – Spare Parts	95
13.2 Regular Visual Checks	64	F.1 Maintenance Kits	95
13.3 Annual Maintenance	64	F.2 Upgrade Kits	95
13.3.1 Annual Maintenance Schedule	64	F.3 Reagents and Reagent Bottles	95
13.3.2 Annual Maintenance Kits	64	F.4 Strategic Spares	97
13.3.3 Maintenance Tools Required	64	F.4.1 Valve Assemblies and Associated Parts	97
13.3.4 Replacing the Valve Diaphragms	64	F.4.2 Side Sample Pot Assemblies and Associated Parts	98
13.3.5 Replacing the Tubing	67	F.4.3 Measurement Head Assemblies and Associated Parts	99
13.3.6 Replacing the Piston Tube and Piston Assembly	70	F.4.4 Plumbing and Tubing	101
13.3.7 Completion	73	F.4.5 Electronic Boards	102
14 Specification	74	F.5 Accessories	103
Appendix A – Reagents	77	Notes	106
A.1 Reagent Solutions	77		
A.1.1 Reagent Storage	77		
A.2 Reagent Consumption	77		
A.3 Consumption of Sample, Standards and Dilution Water	78		
A.4 Cleaning Solutions	78		

1 Safety

Information in this manual is intended only to assist our customers in the efficient operation of our equipment. Use of this manual for any other purpose is specifically prohibited and its contents are not to be reproduced in full or part without prior approval of the Technical Publications Department.

1.1 Health & Safety

Health and Safety

To ensure that our products are safe and without risk to health, the following points must be noted:

- The relevant sections of these instructions must be read carefully before proceeding.
- Warning labels on containers and packages must be observed.
- Installation, operation, maintenance and servicing must only be carried out by suitably trained personnel and in accordance with the information given.
- Normal safety precautions must be taken to avoid the possibility of an accident occurring when operating in conditions of high pressure and/or temperature.
- Chemicals must be stored away from heat, protected from temperature extremes and powders kept dry. Normal safe handling procedures must be used.
- When disposing of chemicals ensure that no two chemicals are mixed.

Safety advice concerning the use of the equipment described in this manual or any relevant Material Safety Data Sheets (where applicable) may be obtained from the Company, together with servicing and spares information.









1.2 Electrical Safety – CEI/IEC 61010-1:2001-2







This equipment complies with the requirements of CEI/IEC 61010-1:2001-2 'Safety Requirements for Electrical Equipment for Measurement, Control and Laboratory Use' and complies with US NEC 500, NIST and OSHA.

If the equipment is used in a manner NOT specified by the Company, the protection provided by the equipment may be impaired.

1.3 Symbols – CEI/IEC 61010-1:2001-2

One or more of the following symbols may appear on the equipment labelling:

	Protective earth (ground) terminal.
	Functional earth (ground) terminal.
	Direct current supply only.
	Alternating current supply only.
	Both direct and alternating current supply.
	The equipment is protected through double insulation.
	This symbol, when noted on a product, indicates a potential hazard which could cause serious personal injury and/or death. The user should reference this instruction manual for operation and/or safety information.
	This symbol, when noted on a product enclosure or barrier, indicates that a risk of electrical shock and/or electrocution exists and indicates that only individuals qualified to work with hazardous voltages should open the enclosure or remove the barrier.
	This symbol indicates that the marked item can be hot and should not be touched without care.

	This symbol indicates the presence of devices sensitive to electrostatic discharge and indicates that care must be taken to prevent damage to them.
	This symbol identifies a risk of chemical harm and indicates that only individuals qualified and trained to work with chemicals should handle chemicals or perform maintenance on chemical delivery systems associated with the equipment.
	This symbol indicates the need for protective eye wear.
	This symbol indicates the need for protective hand wear.
	Electrical equipment marked with this symbol may not be disposed of in European public disposal systems. In conformity with European local and national regulations, European electrical equipment users must now return old or end-of-life equipment to the manufacturer for disposal at no charge to the user.
	Products marked with this symbol indicates that the product contains toxic or hazardous substances or elements. The number inside the symbol indicates the environmental protection use period in years.

1.4 Product Recycling Information



Electrical equipment marked with this symbol may not be disposed of in European public disposal systems after 12 August 2005. In conformity with European local and national regulations (EU Directive 2002/96/EC), European electrical equipment users must now return old or end-of-life equipment to the manufacturer for disposal at no charge to the user.

Note. For return for recycling, please contact the equipment manufacturer or supplier for instructions on how to return end-of-life equipment for proper disposal.

1.5 Product Disposal

Note. The following only applies to European customers.



ABB is committed to ensuring that the risk of any environmental damage or pollution caused by any of its products is minimized as far as possible. The European Waste Electrical and Electronic Equipment (WEEE) Directive (2002/96/EC) that came into force on August 13 2005 aims to reduce the waste arising from electrical and electronic equipment; and improve the environmental performance of all those involved in the life cycle of electrical and electronic equipment.

In conformity with European local and national regulations (EU Directive 2002/96/EC stated above), electrical equipment marked with the above symbol may not be disposed of in European public disposal systems after 12 August 2005.

1.6 Restriction of Hazardous Substances (RoHS)



The European Union RoHS Directive and subsequent regulations introduced in member states and other countries limits the use of six hazardous substances used in the manufacturing of electrical and electronic equipment. Currently, monitoring and control instruments do not fall within the scope of the RoHS Directive, however ABB has taken the decision to adopt the recommendations in the Directive as the target for all future product design and component purchasing. .

1.7 Chemical Reagents

Warning. To familiarize yourself with handling precautions, dangers and emergency procedures, always review the Material Safety Data Sheets prior to handling containers, reservoirs, and delivery systems that contain chemical reagents and standards. Protective eye wear and protective hand wear. is always recommended when contact with chemicals is possible.

1.8 Safety Precautions

Please read the entire manual before unpacking, setting up, or operating this instrument.

Pay particular attention to all warning and caution statements. Failure to do so could result in serious injury to the operator or damage to the equipment.

To ensure the protection provided by this equipment is not impaired, do not use or install this equipment in any manner other than that which is specified in this manual.

1.9 Safety Conventions

Warning. In this manual, a warning is used to indicate a condition which, if not met, could cause serious personal injury and/or death. Do not move beyond a warning until all conditions have been met.

If a warning sign appears on the instrument itself, refer to Precautionary Labels – UL Certification and Electrical Safety – CEI/IEC 61010-1:2001-2 for an explanation.

Caution. A caution is used to indicate a condition which, if not met, could cause minor or moderate personal injury and/or damage to the equipment. Do not move beyond a caution until all conditions have been met.

Note. A note is used to indicate important information or instructions that should be considered before operating the equipment.

1.10 Safety Recommendations

For safe operation, it is imperative that these service instructions be read before use and that the safety recommendations mentioned herein be scrupulously respected. If danger warnings are not heeded to, serious material or bodily injury could occur.

Warning. The installation of the instrument should be performed exclusively by personnel specialized and authorized to work on electrical installations, in accordance with relevant local regulations.

1.11 Service and Repairs

Other than the serviceable items listed in Appendix F, page 95, none of the instrument's components can be serviced by the user. Only personnel from ABB or its approved representative(s) is (are) authorized to attempt repairs to the system and only components formally approved by the manufacturer should be used. Any attempt at repairing the instrument in contravention of these principles could cause damage to the instrument and corporal injury to the person carrying out the repair. It renders the warranty null and void and could compromise the correct working of the instrument and the electrical integrity or the CE compliance of the instrument.

If you have any problems with installation, starting, or using the instrument please contact the company that sold it to you. If this is not possible, or if the results of this approach are not satisfactory, please contact the manufacturer's Customer Service

1.12 Potential Safety Hazards

The following potential safety hazards are associated with operating the analyzer:

- Electrical (line voltage)
- Potentially hazardous chemicals

2 Introduction

The Aztec 600 range are advanced colorimetric analyzers used to measure the levels of iron and aluminium in water treatment plants. They are available in both single- and multi-stream versions; the multi-stream version can sample up to three independent streams sequentially. This manual covers both versions of the analyzer.

The measurement involves the addition of various chemical reagent solutions* to the sample, in a specific order, under constant temperature conditions. The result is a chemical complex, in solution, that has a characteristic color. The absorbance of this colored complex is proportional to the concentration in the original sample, thus making it possible for the measurement to be made optically.

During operation, a signal generated from the sensing system is converted by the analyzer into data and this information is presented on the display.

Analyzer main components are shown in Fig. 2.1. The hinged lower door provides environmental protection for the liquid handling section to ensure stabilized measurement conditions.

To maintain optimum measurement accuracy, the analyzer performs a 2-point calibration automatically by introducing standard solutions of known concentrations. The analyzer utilizes solenoid valves to introduce this solution automatically, at predetermined intervals.

Data is stored in the analyzer's internal memory and can be archived either to an SD Card or via an Internet connection. The SD card can also be used to upgrade the analyzer's software – see Appendix E, page 94.

This manual describes the operation and maintenance of the following Aztec 600 colorimetric analyzers:

- Aztec 600 Aluminium
- Aztec 600 Ammonia
- Aztec 600 Color
- Aztec 600 Iron
- Aztec 600 Manganese
- Aztec 600 Manganese Low Range
- Aztec 600 Phosphate

**For information about reagent solutions, contact the local ABB representative.*

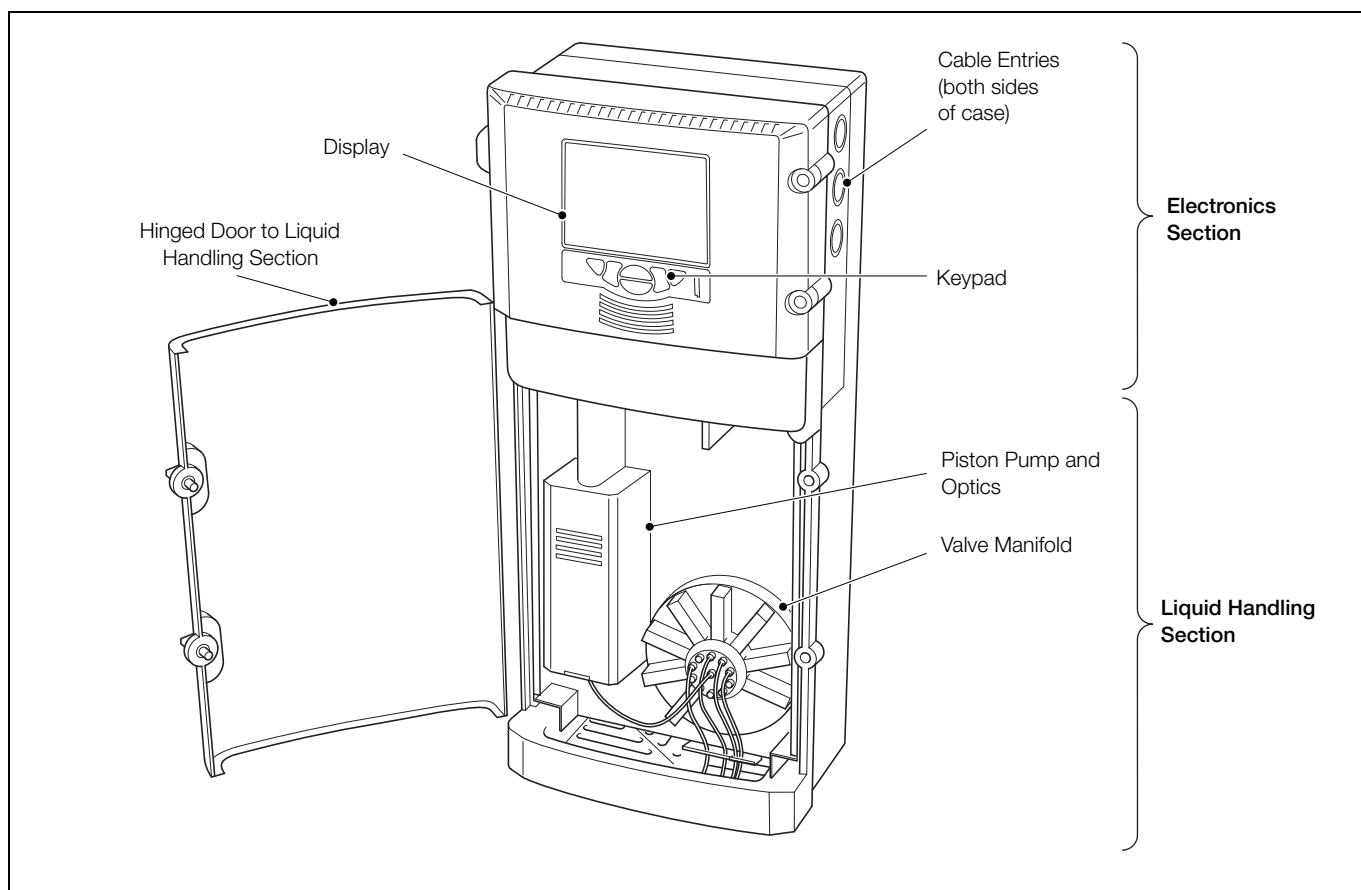
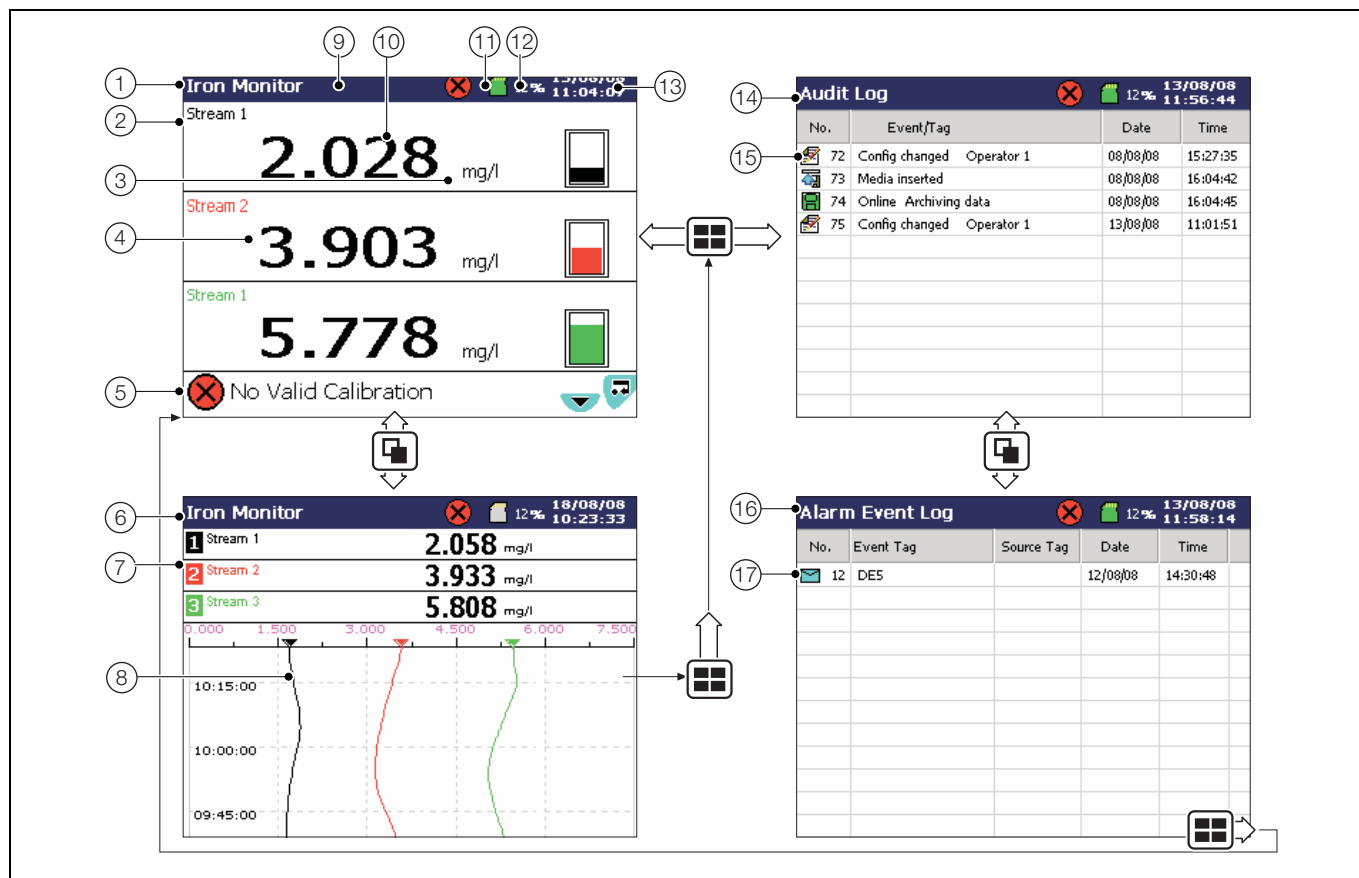

Fig. 2.1 Main Components

2.1 Operator Display Overview

The Operator screen is the default display (shown in either single-stream or multi-stream mode).



Item	Feature	Item	Feature
①	Screen name (multi-stream Operator screen shown)	⑩	Measurement bar
②	Stream number	⑪	Status Icon – see Section 12.3.1, page 61 (Audit Log icons), see Section 12.3.2, page 62 (Alarm Log icons), see Section 12.3.3, page 62 (Status icons)
③	Measurement unit	⑫	Indication of SD card capacity full/empty as a % – associated with displayed status icon
④	Measured value	⑬	Current date and time
⑤	Diagnostic icon and message – see Section 12, page 56	⑭	Audit Log screen
⑥	Chart view (multi stream shown) Note. Alarm Event and Operator Message annotations are not shown on the chart unless enabled – see Section 6.6.1, page 37	⑮	Audit Log icon, event, date and time – see Section 12.3.1, page 61
⑦	Stream numbers, measured values and measurement units	⑯	Alarm Event Log screen
⑧	Chart trace	⑰	Alarm icon, event, date and time – see Section 12.3.2, page 62
⑨	Status bar		

Table 2.1 Overview of Aztec 600 Operator and Log Screens

Notes.

1. Alarm Status

- Flashing red alarm event icon – alarm active and unacknowledged
- Continuous red alarm event icon – alarm active and acknowledged

2. Alarm Event and Operator Message Annotations

If Alarm event annotation is enabled and an alarm becomes active, a red alarm event icon surrounded by a channel colored box is displayed at the point at which the alarm occurred, together with the alarm time and tag, for example:

 11:58:00 1.1A High Level

If more than one alarm occurs in the same sample period:

- and the second alarm on a channel becomes active, its icon is added behind the first.
- and more than one operator message is active (max. 6), a second icon is added behind the first.
- the new alarm event icons appear to the left of earlier icons.
- the time and tag of the oldest alarm (right-most icon) only is displayed.

3 Getting Started

3.1 Overview

The following procedure describes how to start up and configure the analyzer prior to operation.

1. Install the analyzer – see Section 4, page 12.
2. Connect the correct reagents to the analyzer – see Section 4.7, page 20.
3. Switch on power to the analyzer.

After an initial power-up period, the main operator screen is displayed.

4. Press the  key and use the ▲ and ▼ keys to select 'Common Configuration' to configure the analyzer:
 - Setup – see Section 6.1.1, page 26
 - Screen – see Section 6.1.2, page 26
 - Time – see Section 6.1.3, page 27
 - Security – see Section 6.1.4, page 28
 - User – see Section 6.1.5, page 31
 - Operator Messages – see Section 6.1.6, page 31

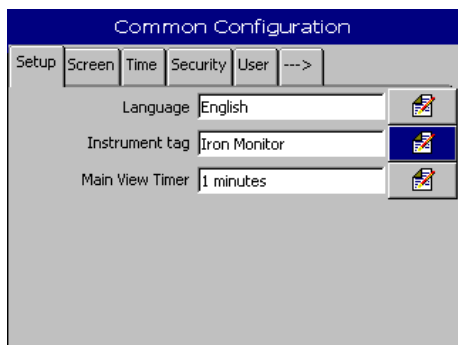



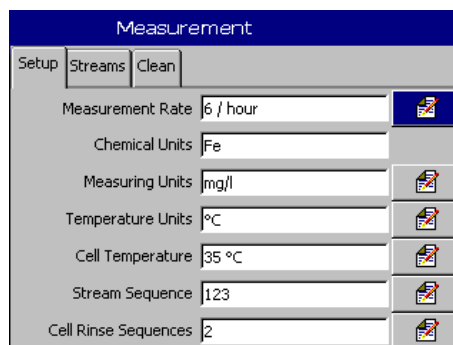

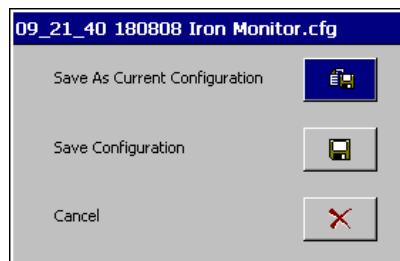

5. Press the  key and use the ▲ and ▼ keys to select 'Measurement' to set up the analyzer measurement parameters:
 - Setup – see Section 6.2.1, page 32
 - Streams – see Section 6.2.2, page 32
 - Clean – see Section 6.2.3, page 32



6. Press the  key and use the ▲ and ▼ keys to select 'Exit' to exit configuration. A prompt is displayed asking if the current configuration is to be saved:



7. Press the  key to save the configuration to the analyzer's internal memory.

8. Press the  key and use the  and  keys to select 'Operate'.
9. Use the  and  keys to select 'Prime lines and Calibrate' and press the  key.

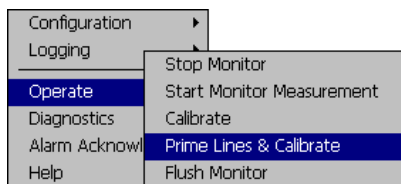

When the priming sequence is complete, a stabilizing period is initiated to allow the measurement cell temperature to stabilize. Once stabilized, calibration is performed automatically; the analyzer then enters measuring mode.

3.2 On-line Help

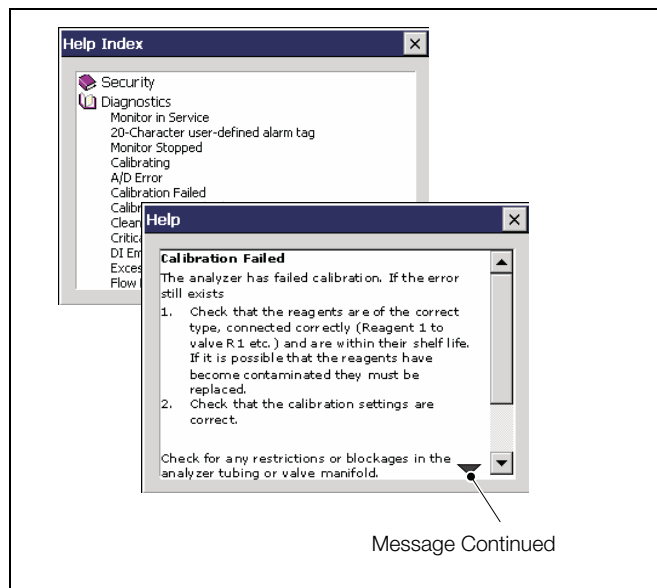







Fig. 3.1 On-line Help

If any alarms or messages appear on the operator screen, press the  key to open the help at the relevant diagnostic help topic. For example, if the 'Calibration Failed' message is active and the help is opened, the help opens at the 'Calibration Failed' diagnostic topic.

1. Press the  key and use the  and  keys to select 'Help'. Press the  key to open the help.
2. To exit the on-line help, press the  key until returned to the screen from where help was selected from.

4 Installation

4.1 Optional Accessories

Optional accessories comprise:

Reagent tray

Profibus capability (including separate manual – part no. IM/AZT6PBS)

4.2 Sampling Requirements

Selection of a good, representative sampling point is critical to obtain optimum performance from the analyzer.

To reduce sample dead time, locate the analyzer as close to the sampling point as possible.

Use small diameter tubing for sampling lines to minimize the lag time but large enough not to block.

The sample must also conform to the following conditions:

- Sample flow rates must be greater than 200 ml/min and less than 500 ml/min.
- Sample temperature must be within the range 1 to 40 °C (32 to 104 °F).
- Samples must not contain particles exceeding 100 microns in size. Above these levels, an external filter must be fitted to the sample lines.
- Sample must be at atmospheric pressure. It must be as close to the analyzer as possible and the sampling point must provide a thoroughly mixed representative sample.

4.3 Location

For general location requirements refer to Fig. 4.1. Install in a clean, dry, well ventilated and vibration-free location giving easy access and where short sample lines can be used. Avoid rooms containing corrosive gases or vapors, for example, chlorination equipment or chlorine gas cylinders.

It is also advisable to have adjacent drains near ground level, so that the waste outlet from the analyzer can be as short as possible, together with maximum fall.

If a reagent tray is used, it must be mounted directly below the bottom plate of the analyzer housing – see Section 4.5, page 14.

The power supply and power isolation switch must be adjacent to the analyzer.

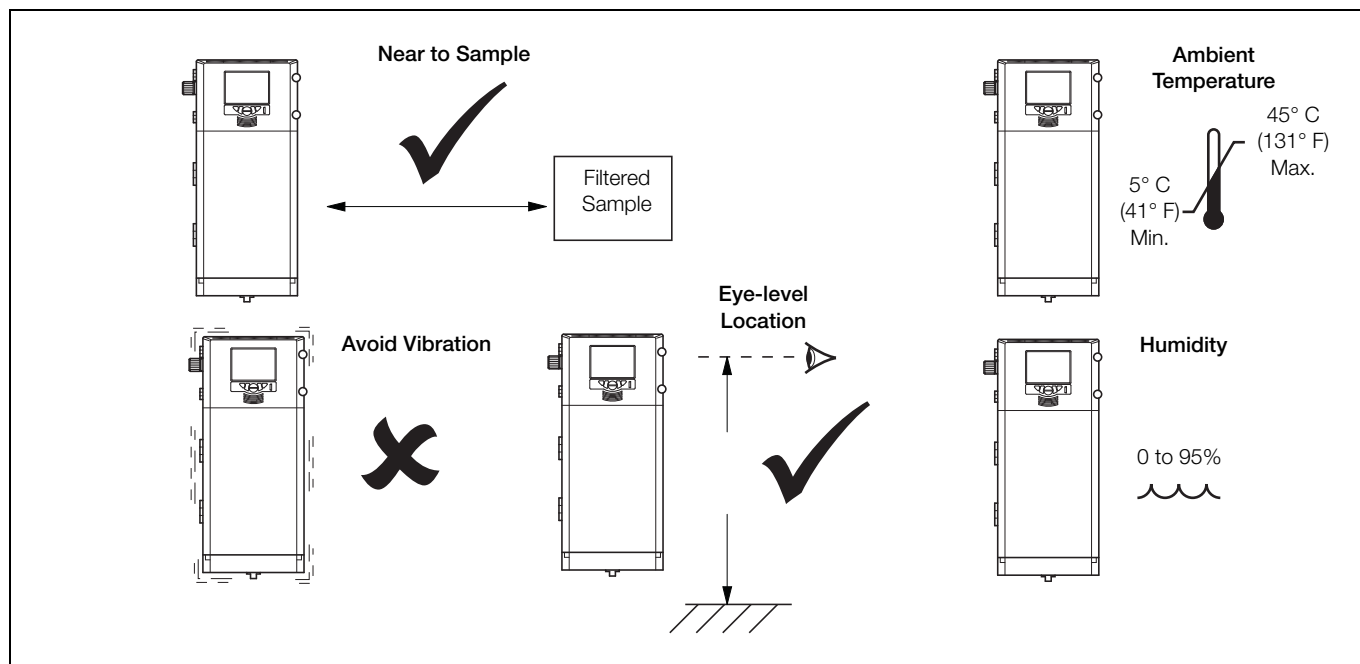

Fig. 4.1 Location

4.4 Mounting

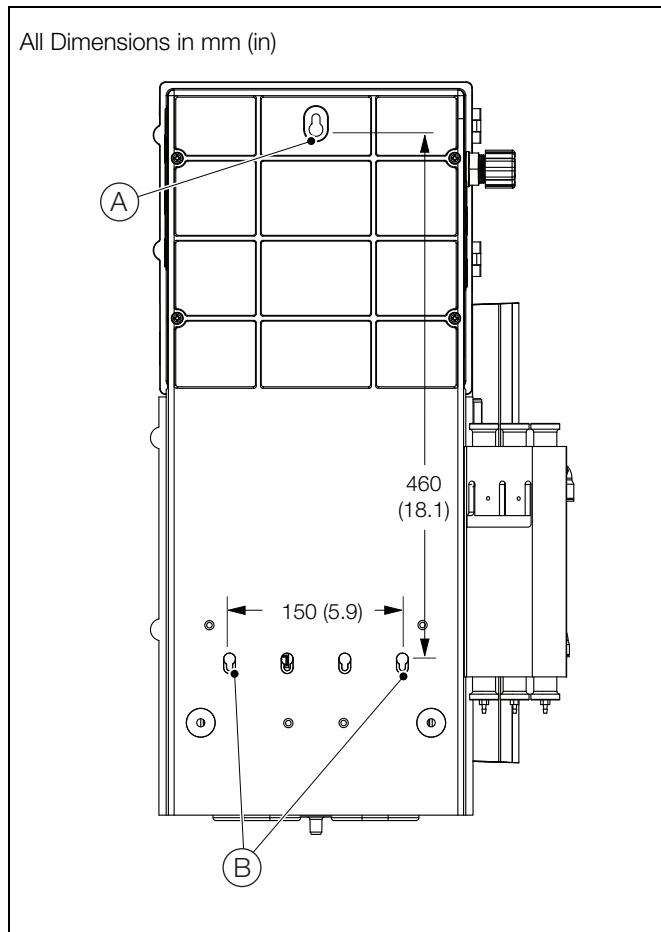

Fig. 4.2 Mounting the Analyzer

Note. Clearance – the enclosure doors can open 180°. If mounting in a confined area, allow sufficient clearance for cables on the door hinge side (min. 270 mm [10.6 in.]) and 100 mm (3.93 in.) on door opening side.

1. Mark the wall using the dimensions shown in Fig. 4.2.
2. Drill and plug the three holes (A) and (B), suitable for M6 or 1/4 in. screws/bolts.
3. Screw in the top bolt (A), leaving a gap of 20 mm (0.78 in.) between the screw head and the wall.
4. Hang the analyzer onto the top bolt.

Note. It is not possible to tighten this screw once the analyzer is attached to the wall.

Hang the analyzer onto the top bolt and check that it is retained firmly against the wall.

5. Secure the analyzer to the wall using two screws (B).

4.4.1 Reagent Mounting Tray (Option)

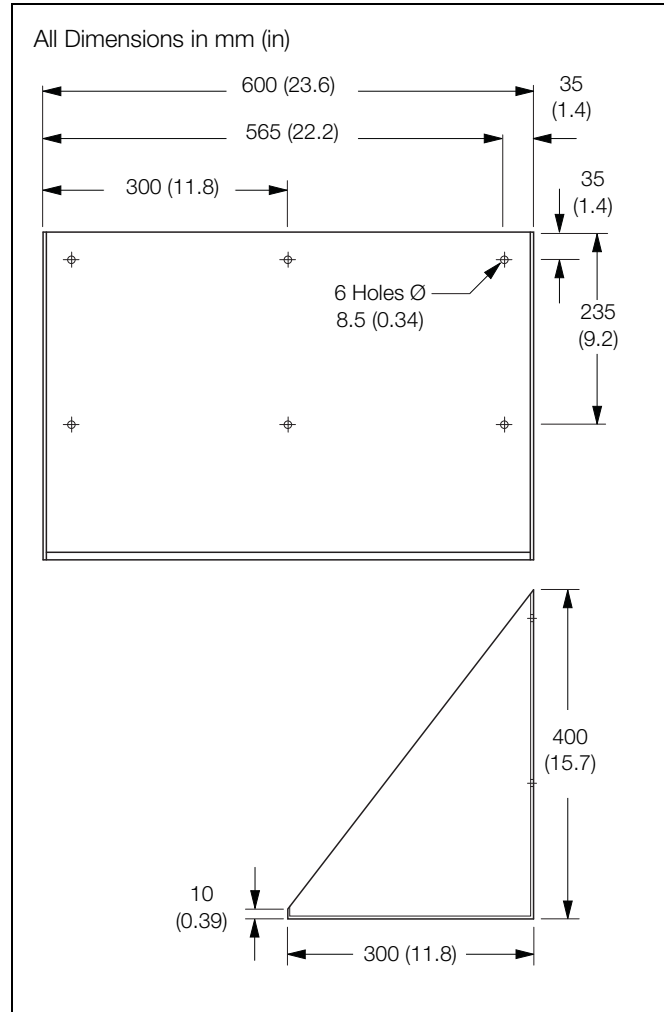

Fig. 4.3 Reagent Mounting Tray (Option)

If used, place the reagent mounting tray no more than 1100 mm (43.3 in) from the analyzer's bottom plate – see Fig. 4.4, page 14.

To secure the shelves to the wall:

1. Mark the wall using the dimensions shown in Fig. 4.3.
Alternatively, with the shelf supported carefully against the wall, mark through the mounting holes.
2. For each tray, drill and plug mounting holes suitable for M8 or 5/16 in. fixings.

4.5 Dimensions

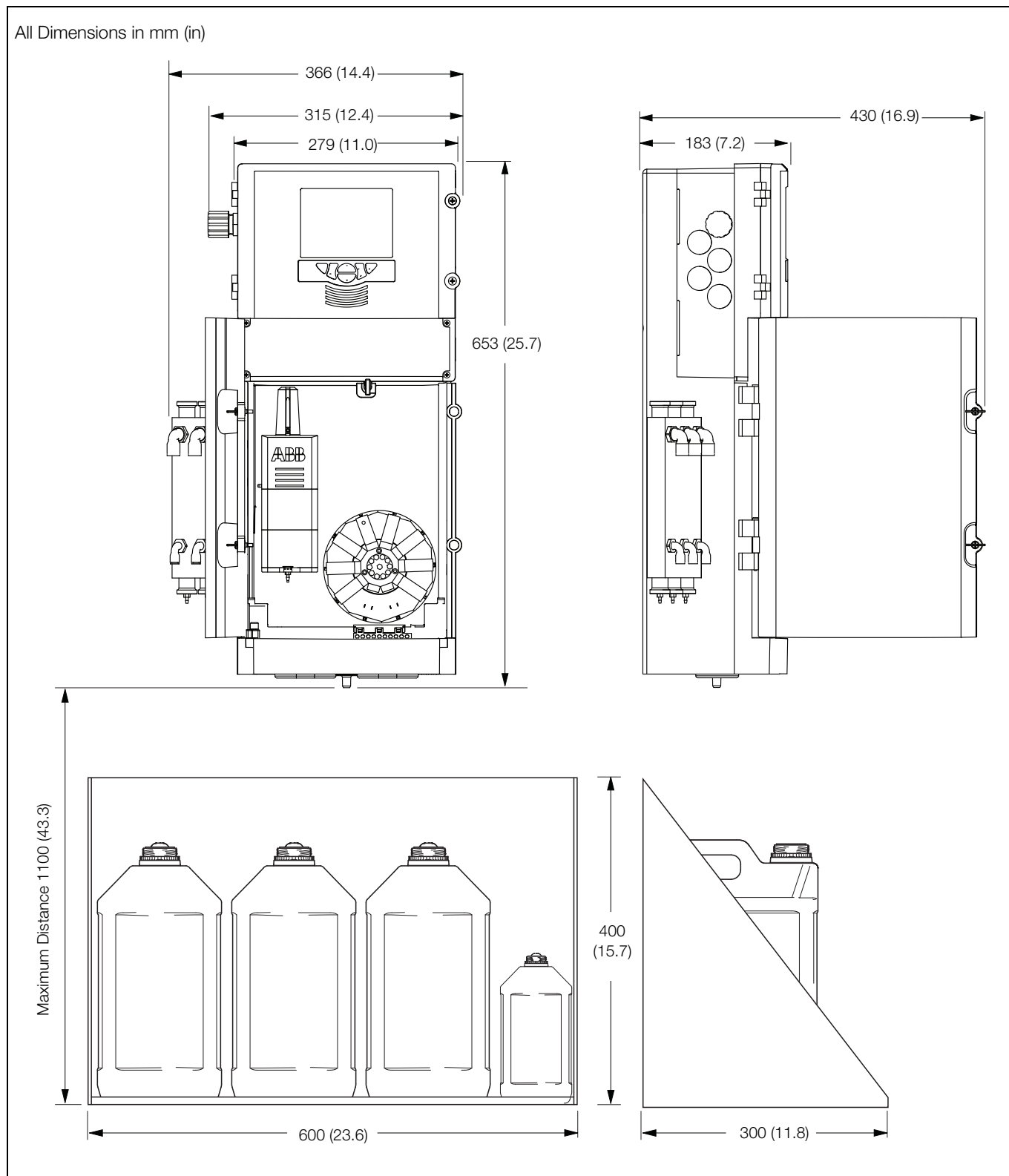

Fig. 4.4 Dimensions

4.6 Electrical Connections

Warning.

- The analyzer is not fitted with a switch therefore a disconnecting device such as a switch or circuit breaker conforming to local safety standards must be fitted to the final installation. It must be fitted in close proximity to the analyzer within easy reach of the operator and must be marked clearly as the disconnection device for the analyzer.
- Remove all power from supply, relay and any powered control circuits and high common mode voltages before accessing or making any connections.
- Use cable appropriate for the load currents: 3-core cable rated 3 A and 75 °C (167 °F) minimum, and voltage: 100/240 V that conform to either IEC 60227 or IEC 60245, or to the National Electrical Code (NEC) for the US, or the Canadian Electrical Code for Canada. The terminals accept cables 0.8 to 2.5 mm² (18 to 14 AWG).
- Ensure the correct fuses are fitted – Fig. 4.7, page 18 for fuse details.
- Use screened cable for signal inputs and relay connections.
- Replacement of the internal battery (type Varta CR2025 3V lithium cell) must be carried out by an approved technician only.
- The analyzer conforms to Installation Category II of IEC 61010.
- All connections to secondary circuits must have insulation to required local safety standards.
- After installation, there must be no access to live parts, for example, terminals.
- If the analyzer is used in a manner not specified by the Company, the protection provided by the equipment may be impaired.
- All equipment connected to the analyzer's terminals must comply with local safety standards (IEC 60950, EN61010-1).
- Route signal leads and power cables separately, preferably in an earthed (grounded) flexible metal conduit.
- The ethernet and bus interface connectors must only be connected to SELV circuits.

USA and Canada Only

- The supplied cable glands are provided for the connection of signal input and ethernet communication wiring ONLY.
- The supplied cable glands and use of cable / flexible cord for connection of the mains power source to the mains input and relay contact output terminals is not permitted in the USA or Canada.
- For connection to mains (mains input and relay contact outputs), use only suitably rated field wiring insulated copper conductors rated min. 300 V, 14 AWG, 90C. Route wires through suitably rated flexible conduits and fittings.

4.6.1 Access to Connections

Note.

- Cable entry holes are located on both sides of the enclosure.
- Application board connection labels for the terminal blocks are identified in Fig. 4.7 on page 18.

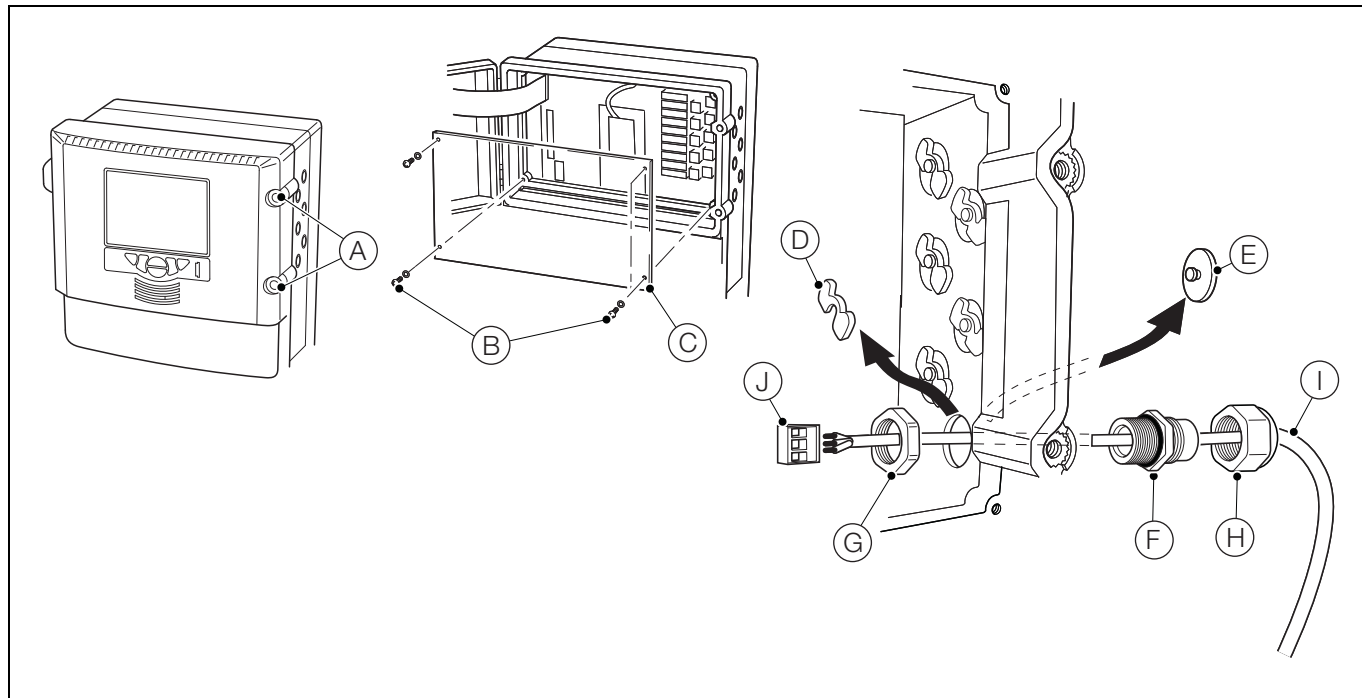

Fig. 4.5 Accessing and Making Electrical Connections

Referring to Fig. 4.5:

1. Turn the two electronics section door retaining screws (A) $\frac{1}{4}$ turn counter-clockwise and open the door.
2. Using a cross-head screwdriver, remove the four screws (B) and remove the transparent cover plate (C).
3. For each cable entry, slide retaining clip (D) off blanking plug (E) and remove the blanking plug.
4. Fit cable gland (F) and secure using nut (G).
5. Remove gland cover (H) and route cable (I) through the gland cover.
6. Route the cable through cable gland (F) and through the enclosure case.

Note. Cable glands are supplied with single- and twin-holed bushes. Use the single-holed bush for the mains power cable.

7. Remove each terminal block connection plug (J) and, using a small flat-bladed screwdriver, make connections to each plug. Ensure wires are connected to the correct terminals – see Fig. 4.7, page 18.
8. Reconnect the terminal block plugs to the appropriate sockets on the application board.
9. Tighten gland nut (H) for each connection made.
10. If required, connect the Ethernet cable – see Section 4.6.2, page 17.
11. When all the connections are made, replace the transparent cover plate (C) and secure using the four screws (B). Close the door to the electronics section and secure by turning the two door retaining screws (A) $\frac{1}{4}$ turn clockwise.

4.6.2 Ethernet Connections

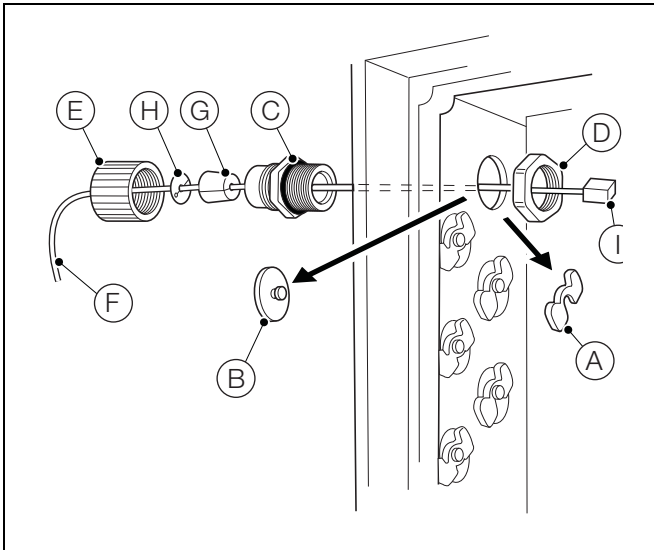

Fig. 4.6 Ethernet Connections

The Ethernet gland is different from the other connections to accommodate an RJ45 plug:

1. Referring to steps 1 and 2 in Section 4.6.1, page 16, open the electronics section door and remove the transparent cover plate.
2. Referring to Fig. 4.6:
 - a. Slide retaining clip (A) off blanking plug (B) and remove the blanking plug.
 - b. Fit cable gland (C) and secure using nut (D).
 - c. Remove gland cover (E) and route cable (F) through it.
 - d. Fit the rubber split-bush (G) and split-washer (H) over the cable.
 - e. Route the cable through cable gland (C) and into the enclosure case.
 - f. Plug the RJ45 connector (I) into the Ethernet RJ45 connector socket on the application board (see Fig. 4.7, page 18 for location details) and tighten gland nut (E).
3. Referring to step 11 in Section 4.6.1, page 16, refit the transparent cover plate and close and secure the electronics section door.

4.6.3 Connections Overview

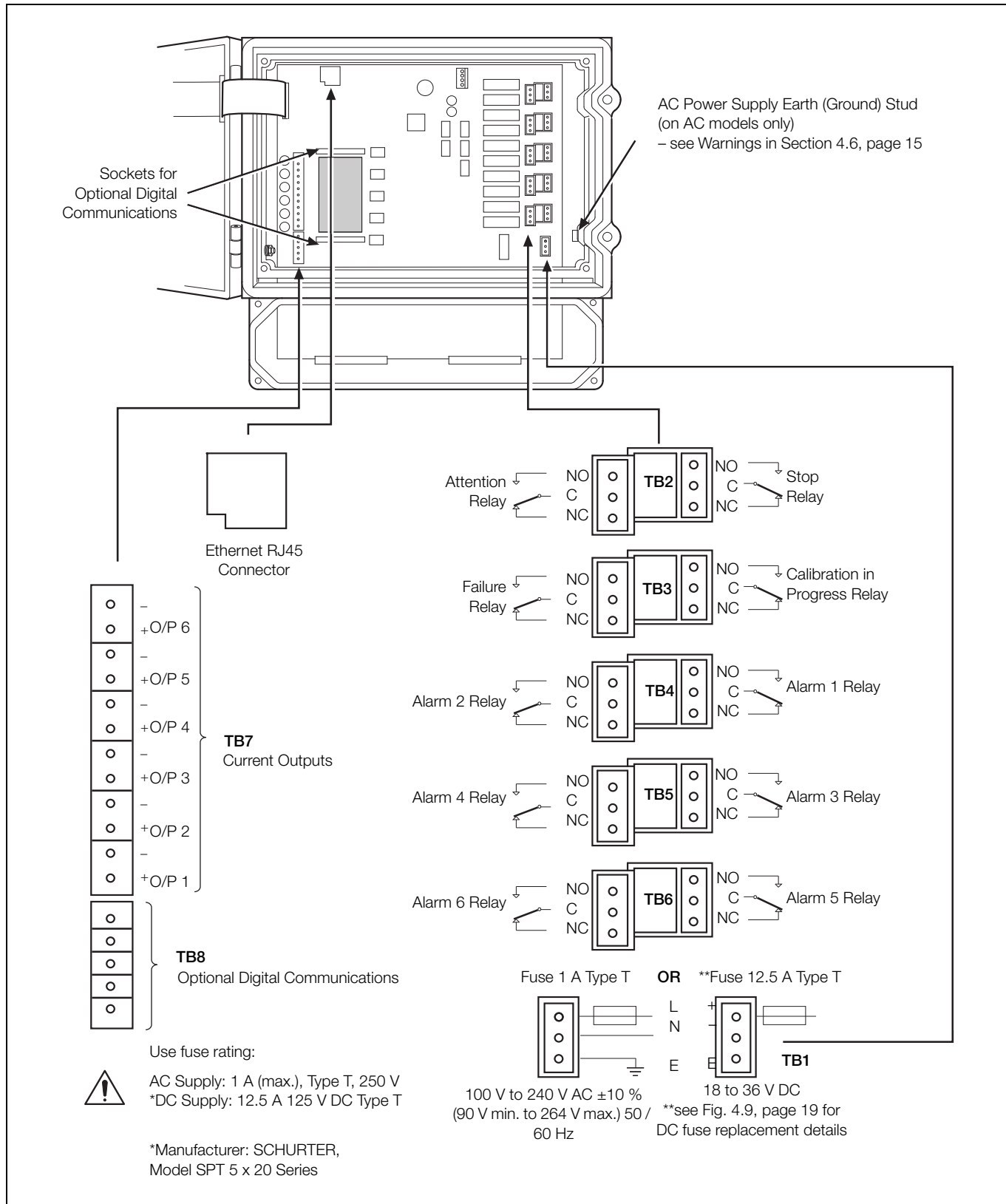

Fig. 4.7 Connections Overview

4.6.4 Replacing the DC Fuse

Caution. Only use replacement fuse: 12.5 A 125 V DC Type T, SCHURTER, Model SPT 5 x 20 Series

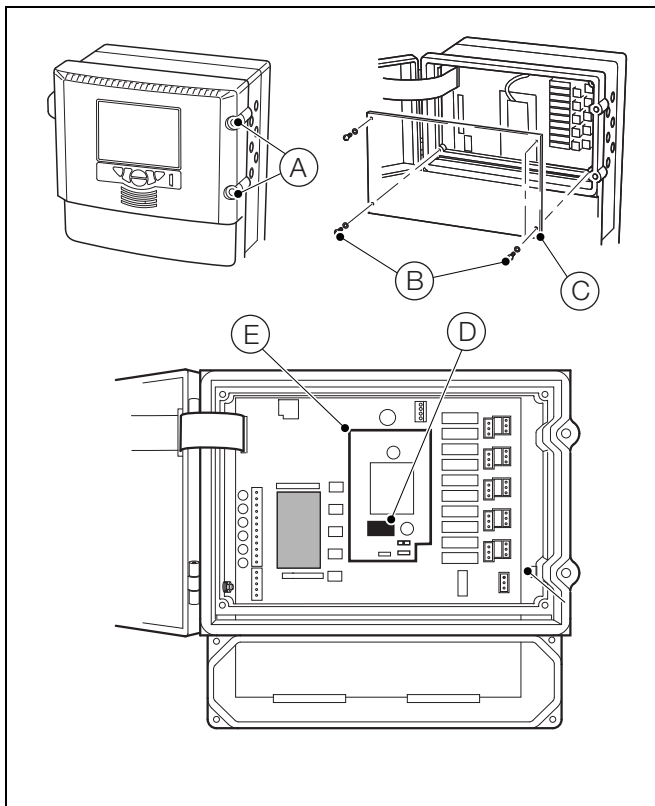

Fig. 4.8 Replacing the DC Fuse

Referring to Fig. 4.8:

Warning. Isolate the analyzer and cables from electrical supply.

1. Open door to the electronics section by unscrewing the two door retaining screws (A) a 1/4 turn.
2. Use a cross-head screwdriver to remove the four screws (B) and remove the transparent cover plate (C).
3. Carefully remove the fuse from the fuse holder (D) on the DC power board (E).
4. Fit a new fuse (12.5 A 125 V DC Type T, SCHURTER, Model SPT 5 x 20 Series) into the fuse holder (D) on the DC power board (E).
5. Replace the transparent cover plate (C) using the four screws (B), close the door to the electronics section and secure by tightening the two door retaining screws (A) a 1/4 turn.

4.6.5 Alarm Relay Contact Protection and Interference Suppression

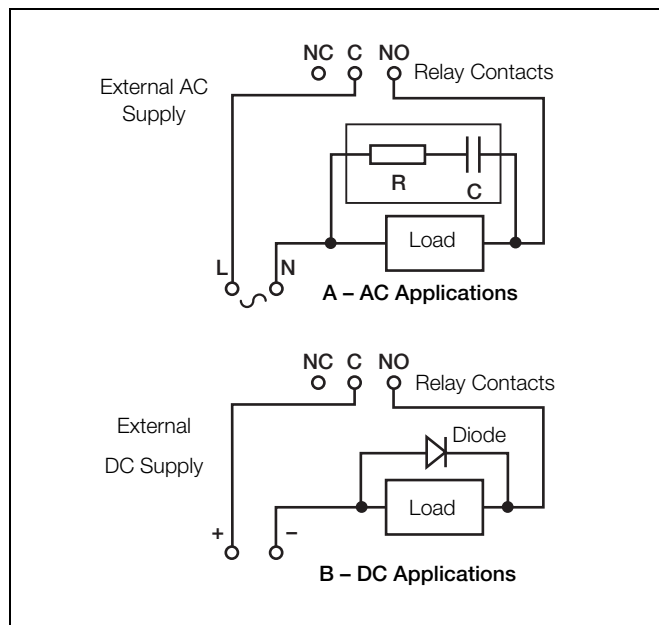

Fig. 4.9 Relay Contact Protection

If the relays are used to switch loads on or off, the relay contacts can become eroded due to arcing. Arcing also produces RFI that can cause analyzer malfunctions and incorrect readings. To minimize the effects of RFI, arc suppression components are required; these are resistor/capacitor networks for AC applications or diodes for DC applications. These components can be connected across the load.

Maximum relay ratings are:

- 250 V, 5 A AC, 1250 VA (non-inductive)
- 30 V, 5 A DC 150 W

For AC applications the value of the resistor/capacitor network depends on the load current and inductance that is switched. Initially, fit a 100R/0.022 μ F RC suppressor unit. If the analyzer malfunctions the value of the RC network is too low for suppression and an alternative value must be used.

For DC applications fit a diode – see Fig. 4.9. For general applications use an alternative IN5406 type (600 V peak inverse voltage at 3 A).

Note. For reliable switching the minimum voltage must be >12 V and the minimum current >100 mA.

4.7 Connecting Sample and Reagents

4.7.1 Connecting Sample Inlet and Drain Line(s)

The sample pot fills with sample and over-flows at the top to maintain a constant head from where sample is taken to be measured.

The sample drain line(s) (B), (D) and (F) (see Fig. 4.11) must be routed to maintain a gravity-fed drain.

The float inside the pot contains a small magnet that operates a reed switch. When the float is in the uppermost position the switch is held closed. If the sample stops flowing the float drops slowly, allowing the reed switch to open, providing a sample flow failure indication.

Single-stream Units

Using rigid nylon tubing:

1. Connect stream 1 to sample inlet connection (A) (6 mm OD tubing).
2. Connect stream 1 drain line to sample outlet connection (B) (10 mm OD tubing).

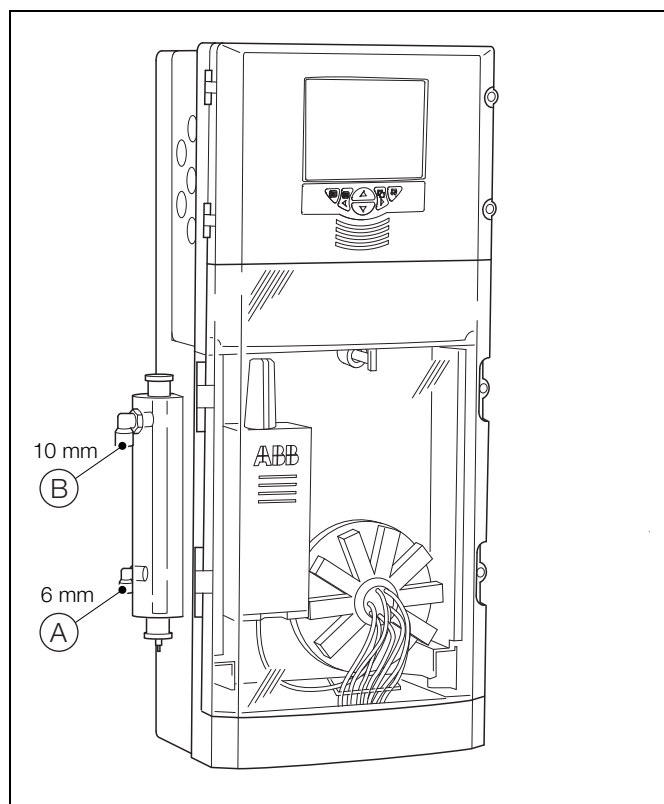

Fig. 4.10 Connecting the Sample Inlet and Drain Line(s) – Single Stream

Multi-stream Units

Using rigid nylon tubing:

1. Connect stream 1 to black sample inlet connection (A) (6 mm OD tubing).
2. Connect stream 1 drain line to black sample outlet connection (B) (10 mm OD tubing).
3. Connect stream 2 to red sample inlet connection (C) (6 mm OD tubing).
4. Connect stream 2 drain line to red sample outlet connection (D) (10 mm OD tubing).
5. Connect stream 3 to green sample inlet connection (E) (6 mm OD tubing).
6. Connect stream 3 drain line to green sample outlet connection (F) (10 mm OD tubing).

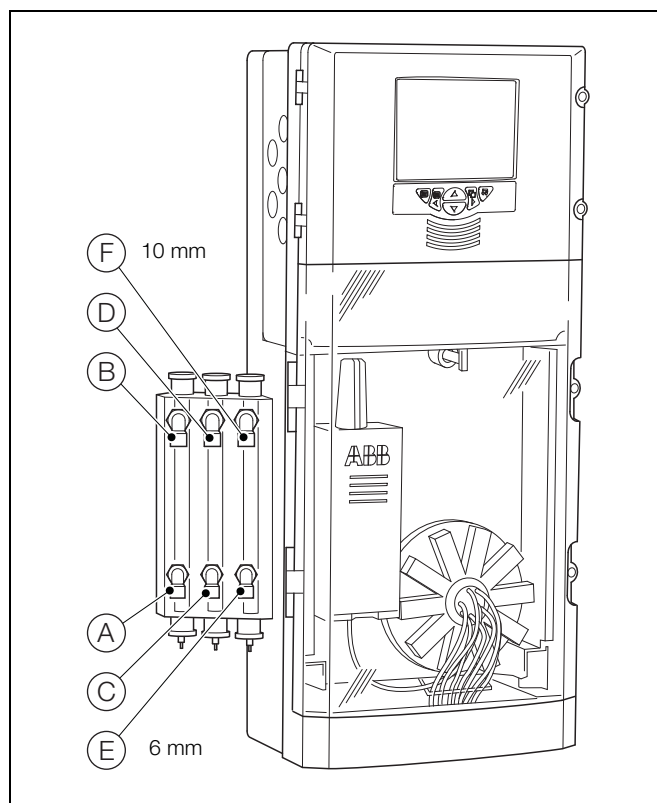

Fig. 4.11 Connecting the Sample Inlet and Drain Line(s) – Multi-stream

4.7.2 Installing Reagents and Reagent Level Sensors

Warning.

- Some reagents contain hazardous chemicals. Ensure that safety information is read and understood before handling reagents.
- Wear appropriate protective clothing when handling reagents.

Care must be taken when installing the reagents to prevent contamination. Keep the reagent level sensor dry and avoid handling the stem. Hold the level sensor by clamp ring (A) – see Fig. 4.12.

Use the following process for each reagent level sensor and container combination:

1. Using a dry, lint-free cloth, remove any foreign matter from level sensor stem (B).
2. Remove the reagent container cap and store in a clean, safe place.
3. Insert the reagent level sensor into the reagent container, ensuring that all connections are still in place.
4. Check that the end of the level sensor is in close proximity to the bottom of the reagent container. Adjustment can be made by loosening (D), moving the sensor to position, retightening (D) and then (A).
5. Secure the reagent level sensor to the reagent container with cap (C).

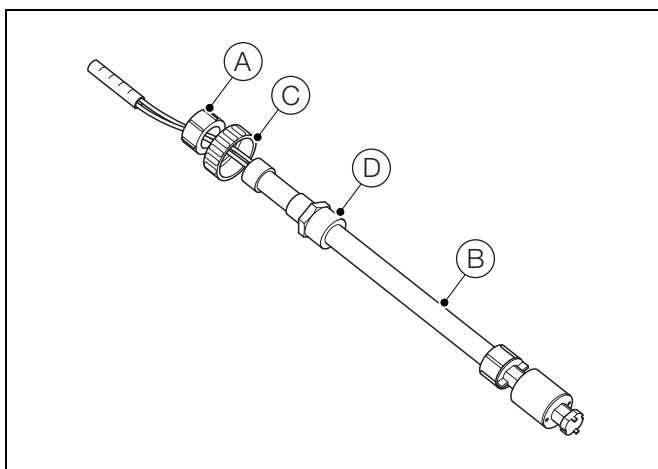

Fig. 4.12 Reagent Level Sensor

4.7.3 Connecting the Analyzer Waste

Analyzer waste is expelled through the dedicated waste port on the valve manifold assembly (identified by a 'W' symbol).

Route analyzer waste tubing to an open waste container or drain in accordance with local regulations.

Caution. Analyzer waste is contaminated with reagents. Dispose of the waste in accordance with local regulations.

Note. Keep the analyzer waste tubing as short as possible and route as vertically as possible to allow free drainage. Ensure no back pressure exists in the waste tubing.

5 Operation



Warning.

Protective eye wear and protective hand wear is recommended when contact with chemicals is possible. Take appropriate Health & Safety precautions.

5.1 Front Panel Controls

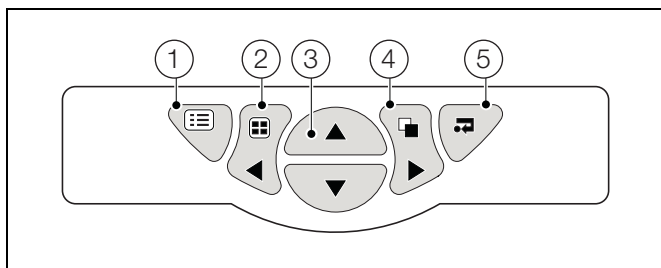

Fig. 5.1 Front Panel Controls

- a **Menu Key** – Displays or hides the context-sensitive operator menu associated with each view. It also cancels the menu without making a change or returns to the previous menu level.
- b **Group Key** – Toggles between the operator and log screens.
Left Key – Scroll left.
- c **Up/Down Keys** – Highlights menu items and scrolls through previously recorded data.
- d **View Key** – Toggles between the operator and chart screens.
Right Key – Scroll right.
- e **Enter Key** – Selects the highlighted menu item, operation button or edit selection.

5.2 Navigation and Editing

Depending on the type of field to be edited, the software provides a variety of methods for entering values.

5.2.1 Text Editing

If the field to be edited requires text, a keyboard is displayed:

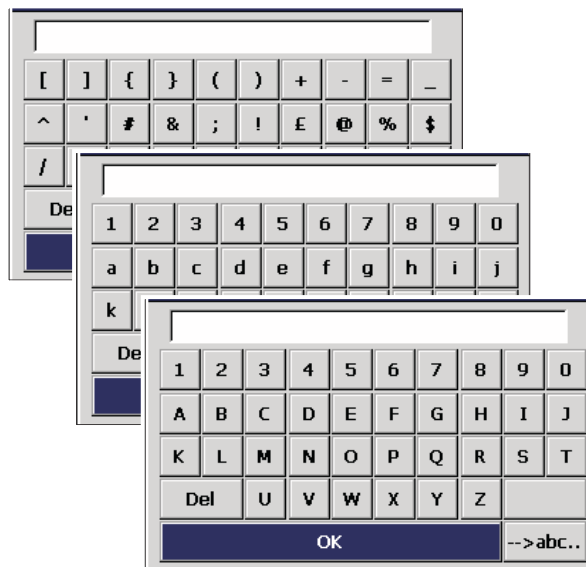

To enter text, use the , , and keys to highlight the required character and press .

There are three set of characters, uppercase, lowercase and symbols. To toggle between each, highlight the bottom, right-hand button and press .

To finish, highlight 'OK' and press or press to exit without making any changes.

5.2.2 Numeric Editing

If the field to be edited requires a numeric value, a number-pad is displayed:

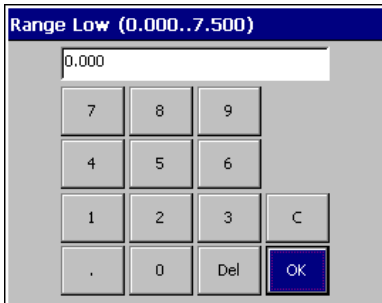

To enter a number, use the ▲, ▼, ◀ and ▶ keys to highlight the required number and press ↵.

To finish, highlight 'OK' and press ↵ or press ⏹ to exit without making any changes.

The 'C' key cancels the edit operation and exits back to the previous screen.

The 'Del' key executes the delete and backspace functions on characters or digits entered in the text box

5.2.3 Other Methods of Editing

There are several other methods of editing, for example:

Checkboxes

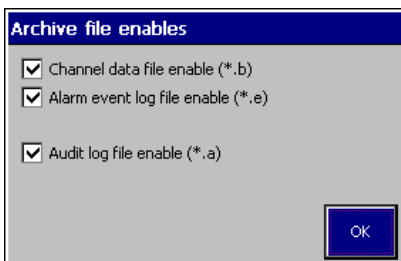

To toggle the selection, use the ▲ and ▼ keys to highlight the required checkbox and press ↵.

To finish, highlight 'OK' and press ↵ to exit and save changes or press ⏹ to exit without making any changes.

Slider Bars

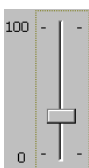

To select a value, use the ▲ and ▼ keys to move the slider.

To finish, press ↵ to exit and save changes or press ⏹ to exit without making any changes.

5.2.4 Tabs

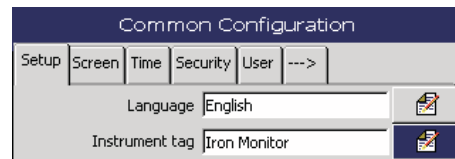

To select a tab, use the ◀ and ▶ keys.

Note. The ---> tab indicates that there are more tabs available.

5.2.4 Menus

Press ⏹ to open the menu and use the ▲ and ▼ keys to select a menu item. Press ↵ to open the menu item:

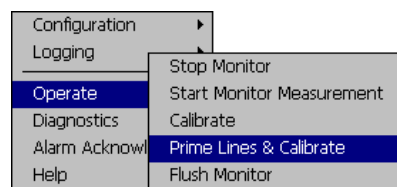

5.3 Software Screen Structure

5.3.1 Indicator View Menus

When menus are accessed from the 'Indicator View', the 'Operate' and 'Diagnostics' menu options are displayed.

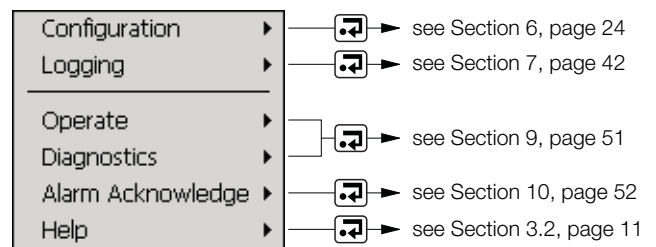

5.3.2 Chart View Menus

When menus are accessed from the 'Chart View', the 'Chart Functions' and 'Statistics' menu options are displayed.

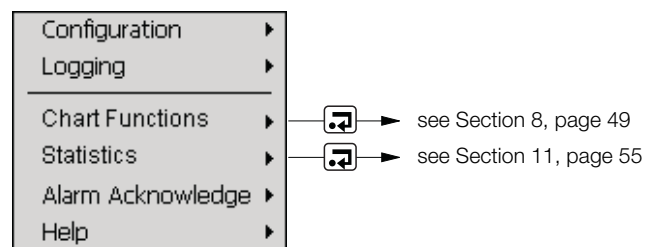

6 Configuration

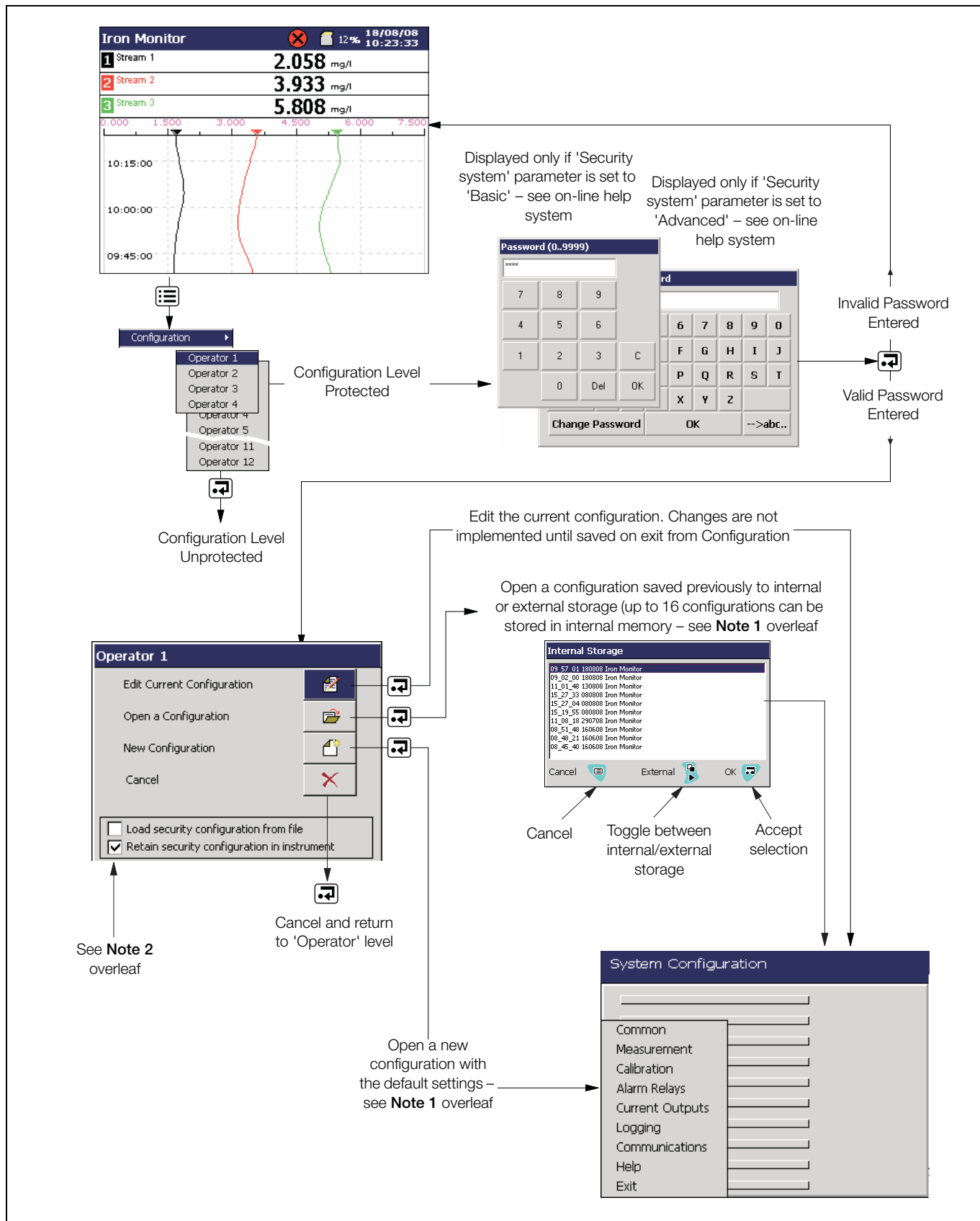

Fig. 6.1 System Configuration

Note. 1

- If 'New Configuration' or 'Open Configuration' is selected and the modified configuration file is saved, new data files for all log files are created and any unarchived data is lost
- Existing security configuration parameters are retained when a configuration is opened from file or when a new configuration is loaded (the security remains as currently configured). Check 'Load security configuration from file' to overwrite the current configuration with data from the file to be loaded.
- The option to load or retain the security configuration applies only to Advanced Security mode and is available only to the System Administrator (User 1 – see Section 6.1.4, page 28). If a new or existing configuration file is opened by a user other than the System Administrator, existing security settings are retained.

Exiting Configuration Level

When exiting Configuration Level, the following conditions apply:

Note. 2

- The current, active configuration is saved to internal storage.
- Selecting 'Save as Current Configuration' suspends recording for a short time while the new configuration is implemented.
- When saving the current configuration to internal storage, the file is saved automatically with a '<time><date><instrument tag>.cfg' filename.
- When saving the current configuration to external storage, the file is saved automatically to internal storage, as well as to the external archive media as '<time><date><instrument tag>.cfg'.
- When 'Save Configuration' is selected, the configuration file is stored as '<time><date><instrument tag>.cfg' on internal or external storage.
- Changes are saved to non-volatile memory only when one of the save options above has been selected. Any powerdown before this results in lost configuration changes.
- Selecting 'Cancel' discards unsaved changes and returns the analyzer to the 'Operate' level.
- New internal data files for enabled recording channels are created if any of the following configuration parameters are changed:
 - Recording channel source
 - Channel tag
- A warning is displayed if a configuration change results in the creation of new internal data files for enabled recording channels. Select 'Yes' to accept the configuration change. Select 'No' to cancel the configuration change.

6.1 Common

There are nine tabs in the Common screen:



6.1.1 Setup

Fields	Description
Language	Lists the available languages. A new language selection does not take effect until the configuration is saved.
Instrument Tag	The analyzer's instrument tag text is displayed in the top-left corner of the operator views. Up to 20 characters can be used. The instrument tag is also displayed on the analyzer on configuration files and audit log files.
Main View Timer	The time after no key presses the display reverts to the main operator screen (excludes 'Configuration' screens).

6.1.2 Screen

Fields	Description
Screen saver wait time	The time delay for the screen-saver. The screen dims after the time set.
Screen Capture	Toggles between 'Enabled' and 'Disabled'. Note. An SD card must be fitted for screen capture. If enabled, press  to capture the current log or chart screen to the VRD\BMP folder on the SD card. A confirmation dialog box is displayed for each screen capture.
Brightness	Adjusts the brightness of the screen.

6.1.3 Time

Fields	Description
Date and Time	Warning. Changing the time can result in the permanent loss of data. Once it is changed a warning is displayed stating that recording is disabled until the configuration has been saved.
Daylight Saving – Enable	Enables automatic daylight saving time adjustment. Options are: <ul style="list-style-type: none"> ■ Off. The 'Daylight Saving – Start' and 'Daylight Saving – End' fields are not available. ■ Auto – USA. The start and end of the daylight saving period in the USA is calculated automatically. The clock is incremented automatically by 1 hour at 2:00 am on the second Sunday in March and decremented automatically by 1 hour at 2:00 am on the first Sunday in November. ■ Auto – Europe. The start and end of the daylight saving period in Central Europe is calculated automatically. The clock is incremented automatically by 1 hour at 2:00 am on the last Sunday in March and decremented automatically by 1 hour at 2:00 am on the last Sunday in October. ■ Auto – Custom. The start and end date and time can be edited.
Daylight Saving – Start	If 'Daylight Saving – Enable' is set to USA or Europe, the start date is displayed but cannot be edited. If 'Daylight Saving – Enable' is set to 'Custom' the date and time can be edited.
Daylight Saving – End	If 'Daylight Saving – Enable' is set to USA or Europe, the end date is displayed but cannot be edited. If 'Daylight Saving – Enable' is set to 'Custom' the date and time can be edited.

6.1.4 Security

The analyzer is fitted with an internal security switch that, in combination with the 'Configuration security' parameter settings (see page 29), is used to prevent unauthorized access to the Configuration Level.

Two methods of configuration access protection are available:

1. **Password protection** (Factory Default)

The Configuration level can be accessed only when the correct password has been entered.

2. **Internal security switch protection**

The Configuration level can be accessed only when the internal security switch is set to the 'Enabled' position.

Internal Security Switch Setting (see Fig. 6.2)	'Configuration security' parameter setting (see page 29)	
	'Password protected' (Factory Default)	'Internal switch protected' (Alternative)
Disabled (Factory Default)	Password Access	No Access
Enabled	Free Access	Free Access

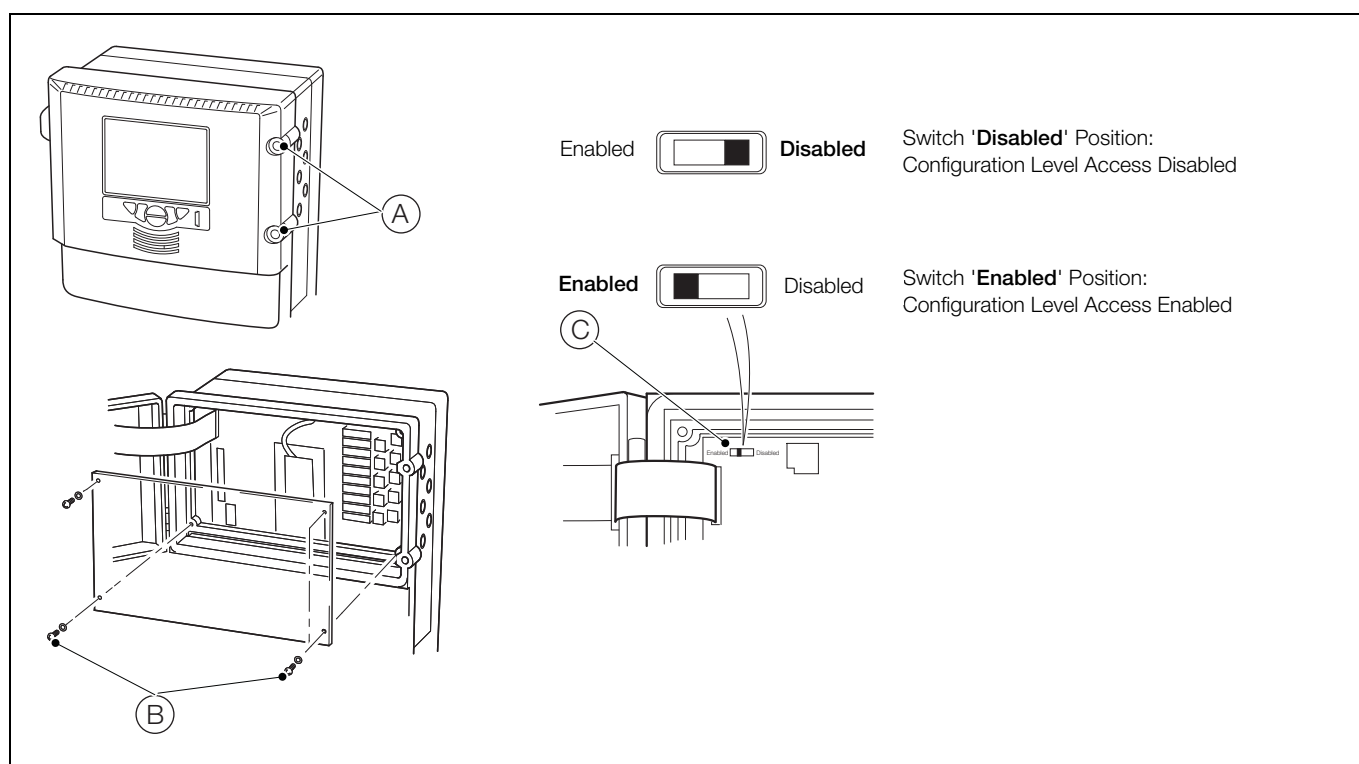

Fig. 6.2 Accessing the Internal Security Switch

To access the internal security switch:

1. Switch off the power supply to the analyzer and turn the two door retaining screws (A) 1/4 turn counter-clockwise.
2. Using a cross-head screwdriver, remove the four cover plate retaining screws (B) and remove the cover plate.
3. Set the security switch (C) to the required position.

Note. The Internal Security Switch is, by default, set to 'Disabled' and should only be used to access the Configuration level when 'Configuration security' is set to 'Internal switch protected' – see page 29. **Do Not** use the switch to access the Configuration level when 'Configuration security' is set to 'Password protected' (default setting) unless the Password has been forgotten. The switch overrides Password protection, enabling free access to the Configuration level.

Note. User 1 is the **System Administrator** and the only user with access to the 'Security type' parameter – see Table 6.1.

User 1	User 1 (System Administrator) Security Rights
System Administrator	Set initial password-protected access to Calibration & Maintenance and Logging menus.
	Is the only user with access to the 'Security type' parameter.
	Set initial password-protected access to the Configuration menu when 'Security type/Configuration security' parameter is set to 'Password Protected'.
	Set initial user permissions – other users can subsequently change their own passwords if permission has been set by User 1.
	Set password expiry dates and disable Inactive user accounts after a set time.
	Set password failure limits and minimum password lengths

Table 6.1 System Administrator Security Rights

Fields	Description
Security type	<p>A page opens with two fields:</p> <ul style="list-style-type: none"> ■ Security system – toggles between 'Basic' and 'Advanced'. <ul style="list-style-type: none"> – Basic: <p>Allows access to the 'Configuration' menu for up to four users (User 1 to 4) – a unique password of up to four digits can be set for each user.</p> <p>A separate password can be set to access the 'Calibration & Maintenance' and 'Logging' menus – up to four users share this password.</p> – Advanced: <p>Allows up to twelve users password-protected access to any of the 'Configuration', 'Calibration & Maintenance' or 'Logging' menus.</p> <p>Each user can be assigned a unique 20-digit (alphanumeric) case-sensitive password (minimum password lengths can be set).</p> ■ Configuration security – toggles between 'Password protected' and 'Internal switch protected'. <ul style="list-style-type: none"> – Password protected (factory default): <p>With the internal security switch set to 'Disabled' (factory default), the 'Configuration' level can be accessed only when the correct password is entered.</p> – Internal switch protected: <p>With the internal security switch set to 'Disabled' (factory default), the 'Configuration' level cannot be accessed.</p> <p>Note. If the internal security switch is set to 'Enabled', the Configuration Level can be accessed without the need to enter a password and should be used only if the password has been forgotten.</p> <p>See Fig. 6.2 on page 28 for switch positions.</p>

Fields	Description
Operator level security	<p>Sets access to the 'Calibration & Maintenance' and 'Logging' menus.</p> <p>If set to 'Off', no password is required.</p> <p>If set to 'On' and 'Security type' is set to 'Basic' an additional 'Operator level password' field is displayed.</p> <p>If set to 'On' and 'Security type' is set to 'Advanced', all users are required to enter their user password to gain access to the 'Calibration & Maintenance' and 'Logging' menus.</p>
Operator level password	<p>Displayed only if 'Security system' is set to 'Basic' and 'Operator level security' is set to 'On'. All users are required to enter this password to gain access to the 'Calibration & Maintenance' and 'Logging' menus.</p>
<p>The following fields are displayed only if 'Security system' is set to 'Advanced'.</p>	
Reconfigure preset	<p>Passwords are set initially by User 1 (System Administrator) but any user can make subsequent changes to their own password.</p> <p>When set to 'Yes' each user must change their password after it is used for the first time following initial configuration.</p>
Password expiry	<p>Select the number of days that the password is valid for. When a password expires, the user is prompted to provide a new password.</p>
Inactive user disabling	<p>Select the number of days after which an inactive user's access privileges are de-activated.</p>
Password failure limit	<p>Enter the number of consecutive incorrect password entries allowed by a user. If the number of incorrect entries exceeds this limit, the user's access privileges are de-activated and can be reinstated only by the System Administrator (User 1).</p>
Min password length	<p>Sets the minimum length required for user's passwords.</p>

6.1.5 User

Fields	Description
<p>If 'Security system' is set to 'Basic' this tab lists the four users, User 1 to User 4. Selecting a user opens a new page with two fields:</p> <ul style="list-style-type: none"> ■ Name – the user's name, up to 20 characters. ■ Password – each user can be assigned a unique 4-digit security code for Configuration level access. 	
<p>If 'Security System' is set to 'Advanced' and User 1 (administrator) is logged on, the 'User' tab shows additional fields:</p>	
User 1 Name	User 1 identification tag – up to 20 characters.
User 1 Access	A page opens with two checkboxes to select whether User 1 has 'Calibration and Maintenance' and/or 'Logging access'.
User 1 Password	User 1's password – a unique 20-character (alphanumeric) security code. A minimum password length applies.
View/Edit Other Users	Selects the other user's access levels and passwords. If selected additional fields appear:
User X Name	Where X is the user number (2 to 12) – up to 20 characters can be used.
User X Access	Where X is the user number (2 to 12). A dialog box is displayed listing the access available for the user: <ul style="list-style-type: none"> ■ Logging ■ Configuration (No access) ■ Configuration (Load) ■ Configuration (Limited) ■ Configuration (Full)
User X Password	Where X is the user number (2 to 12). The password for User X.
<p>If 'Security System' is set to 'Advanced' and a user other than User 1 is logged on, the 'User' tab has three fields. These fields can be edited only if User 1 has set the security field 'Reconfigure preset' to 'Yes' – See page 30. Where X is the user number (2 to 12).</p>	
User X Name	User X identification tag. Up to 20 characters.
User X Access	Where X is the user number (2 to 12). A dialog box is displayed listing the access available for the user: <ul style="list-style-type: none"> ■ Logging
User X Password	User X's password – a unique 20-character (alphanumeric) security code. A minimum password length applies.

6.1.6 Operator Messages

Fields	Description
Messages	Up to 24 messages can be defined to indicate a particular event or action has occurred. These are displayed on the chart when the relevant annotation is enabled.

6.2 Measurement

There are three tabs in the Measurement screen:

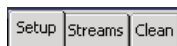

6.2.1 Setup

Fields	Description
Measurement Rate	Sets the number of samples analyzed per hour.
Chemical Units	For certain parameters there is a choice of units to display the results.
Measuring Units	The results can be expressed in a variety of units, for example by weight (mg or µg) or by volume (ppm or ppb).
Temperature Units	The results can be expressed in either Celsius (°C) or Fahrenheit (°F).
Cell Temperature	The cell is temperature controlled and can be set at temperatures between 25 °C (77 °F) and 50 °C (122 °F).
Stream Sequence	In multi-stream analyzers the streams are measured one after the other. This facility allows the operator to set the stream sequence, for example stream 1,2,1,2,3 or 1,2,3,3,1,1 etc.
Cell Rinse Sequences	Number of times the cell is rinsed with sample prior to measurement. Configurable between 1 and 4 rinses.

6.2.2 Streams

Fields	Description
Stream 1 (2 & 3)	The Stream tag text is displayed in the operator views. Up to 20 characters can be used. The Stream tag is also displayed in the configuration files and audit log files.
Stream 1 (2 & 3) Dilution Ratio	Sets the 'Max. Dilution Factor' values for each stream. Notes. <ul style="list-style-type: none"> ■ Changing the Dilution Ratio affects the analyzer range. For example:if the analyzer range is 0 to 5 ppm, changing the dilution ratio from the default of 1:5 to 1:1 reduces the analyzer range to 0 to 2 ppm. ■ The Aztec 600 Manganese Low Range does not operate in dilution mode.

6.2.3 Clean

Fields	Description
Cleaning Mode	Enables and sets the automatic cleaning mode. This can be configured to occur at calibration or during measurement.
The following fields are displayed only if 'Cleaning Mode' is set to 'Measure' or 'Calibrate'.	
Port	Sets the port the cleaning solution is attached to
Cell/Sample Lines	User can select whether to clean the measuring cell and sample lines or the measuring cell only.
The following field is displayed only if 'Cleaning Mode' is set to 'Measure'.	
Cleaning Frequency	Sets the hourly frequency of the cleaning routine (1 to 24).

6.3 Calibration

There is one tab in the Calibration screen for the aluminium, ammonia, iron, manganese and phosphate analyzers.

There are two tabs the Calibration screen for the color analyzer:

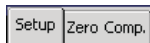

6.3.1 Setup

Fields	Description
Calibration Time	The time the analyzer calibrates.
Calibration Date	The next date when a calibration is due.
Calibration Frequency	Frequency at which an automatic calibration is performed.
Low Standard	The concentration of the low standard.
High Standard	The concentration of the high standard.
Gradient Coefficient	The gradient coefficient is an indication of the variation between the actual calibration curve and the ideal calibration curve. A limit to the gradient coefficient can be set (ideal coefficient =1). Above this limit the analyzer fails a calibration. Default fail criteria occurs when the coefficient exceeds 1 ± 0.6 .
Calibration Fail Event	If this is set to 'FAIL' (default) after a calibration failure the analyzer stops and displays a failed calibration message. If the feature is set to 'ATTENTION' the analyzer continues running after a failed calibration (using the last valid calibration data). The failed calibration data can be viewed in the 'Audit Log'.

6.3.2 Zero Compensation (Aztec 600 Color only)

Fields	Description
Zero Compensation Frequency	Frequency at which the analyzer performs a zero compensation measurement to account for any optical variations such as cell fouling when measuring manganese rich waters.

6.4 Alarm Relays

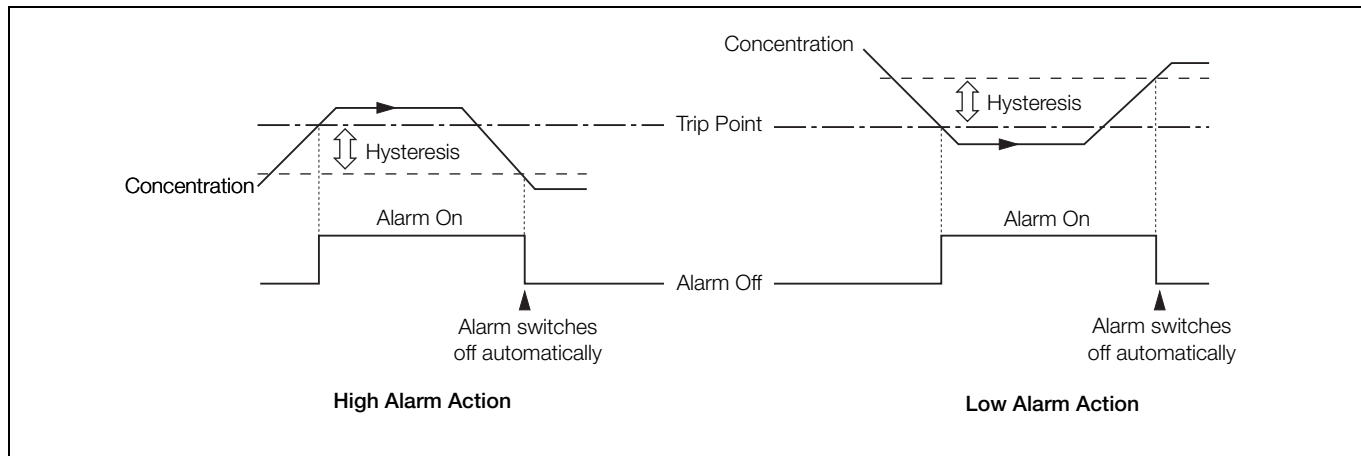

Fig. 6.3 High/Low Process Alarms

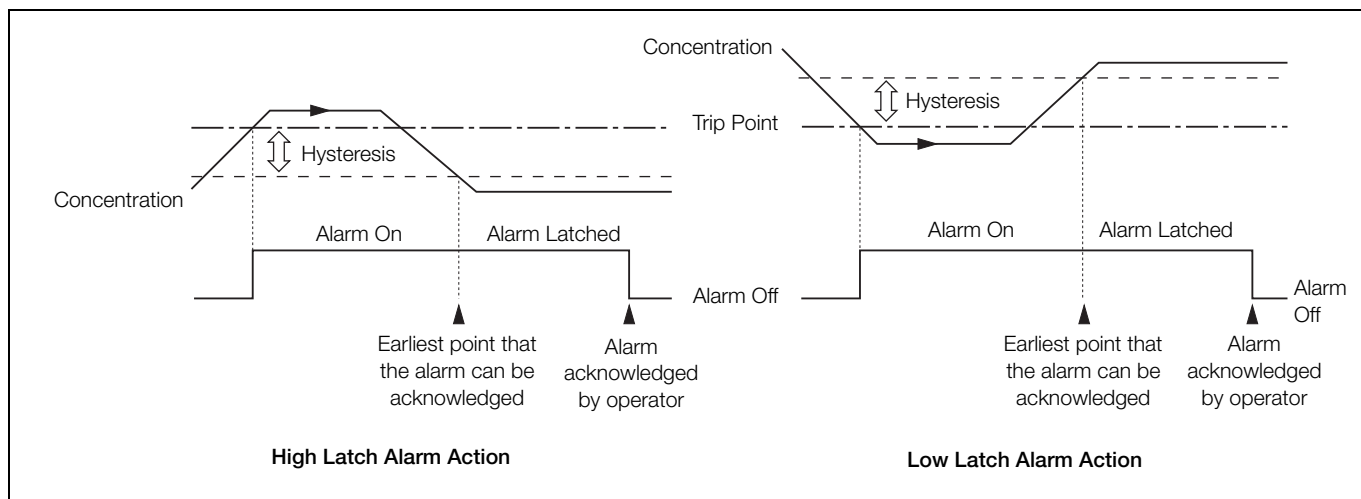

Fig. 6.4 High/Low Latch Alarms

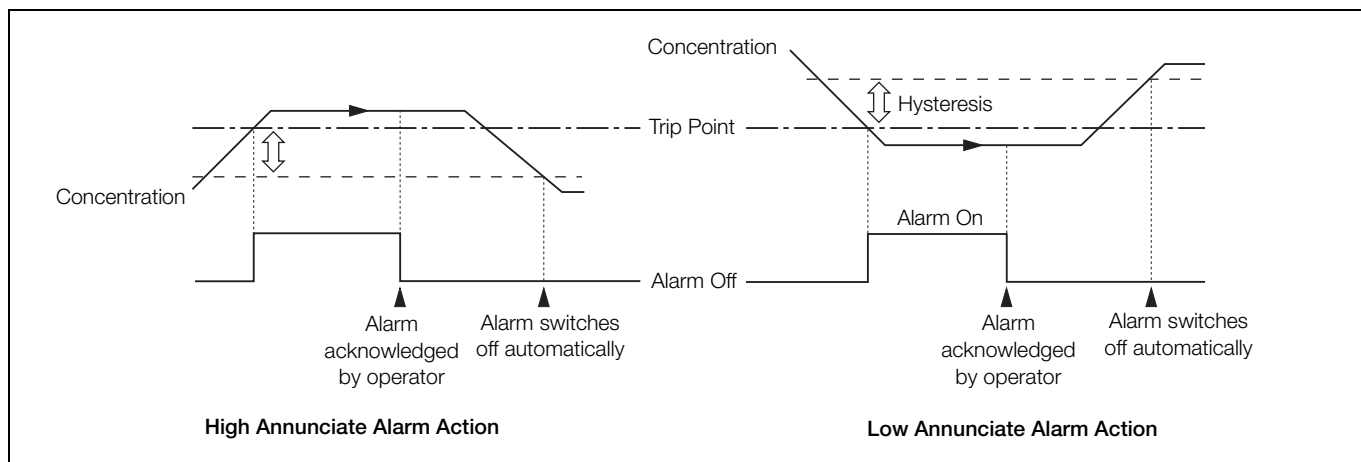

Fig. 6.5 High/Low Annunciate Alarms

There are six tabs in the Alarm Relays screen, one for each alarm:

Alarm A	Alarm B	Alarm C	Alarm D	Alarm E	Alarm F
---------	---------	---------	---------	---------	---------

Fields	Description
Alarm Source	Each of the six alarms can be configured independently to one of the following sources: <ul style="list-style-type: none"> ■ None – no other fields are visible ■ Stream 1 to Stream 3
The following fields are displayed only if 'Alarm Source' is set to 'Stream X':	
Alarm Type	If 'Alarm Source' is set to Stream X, the alarm type can be set to: <ul style="list-style-type: none"> ■ High/Low process – see Fig. 6.3, page 34. ■ High/Low latch – see Fig. 6.4, page 34. ■ High/Low annunciate– see Fig. 6.5, page 34. ■ Out of sample – the alarm state is active if an out-of-sample condition occurs in the selected stream source.
Alarm Tag	The Alarm identification tag – up to 20 characters.
Trip	The value at which the alarm is to activate.
Hysteresis	When an alarm trip value is exceeded, the alarm does not become active until the time hysteresis value has expired. If the signal goes out of the alarm condition before the time hysteresis has expired, the hysteresis value is reset – see page 34 for hysteresis actions. The hysteresis value is set in concentration units, and the hysteresis time is set in seconds (0 to 5000 s).
Fail Safe	If set to 'Yes' the alarm relay is normally energized and is de-energized when an alarm condition occurs. If set to 'No' the alarm relay is normally de-energized and is energized when an alarm condition occurs.
Log Enable	If set to 'On' all changes in the alarm state in the Alarm Event log are recorded – see Section 7.5.3, page 47.

6.5 Current Outputs

There are seven tabs in the Outputs screen, one for each output and an output calibration tab:

Out 1	Out 2	Out 3	Out 4	Out 5	Out 6	O/P Cal.
-------	-------	-------	-------	-------	-------	----------

6.5.1 Outputs 1 to 6

Fields	Description
Output Source	The 'Output Source' field has several options: <ul style="list-style-type: none"> ■ None – no other fields are visible ■ Stream 1 to Stream 3
The following fields are displayed only if 'Output Source' is set to 'Stream X':	
Output Range	The high and low limits for the output range. Both values can be set independently. If the difference between the zero and span is too small, the output is very noisy.
Output Type	The electrical high and low limits (0 to 22 mA). For example, if the output range is set to 0 to 2000 ppb and the 'Output Type' to 4.00 to 20.00 mA, at 0 ppb the output is 4.00 mA and at 2000 ppb the output is 20.00 mA.
Calibration Hold	If set to 'Yes', the output value remains at the level prior to calibration.
Out of Sample Ind.	Out of sample indicator. If set to 'Yes', the output goes to the default output value when an out of sample condition occurs for the selected stream source.
The following field is displayed only if 'Out of Sample Ind.' is set to 'Yes':	
Default Output	The output value used when an out of sample condition occurs and 'Out of Sample Ind.' is set to 'Yes' (0 to 22 mA).

6.5.2 Output Calibration

Fields	Description
Calibrate Output 1 (to 6)	Enables each output to be calibrated.

6.6 Logging

There are three tabs in the 'Logging' screen:

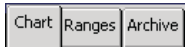

6.6.1 Chart



Fields	Description
Chart view enable	The orientation and direction of the chart display. Options are: <ul style="list-style-type: none"> ■ Horizontal --> ■ Horizontal <-- ■ Vertical
Chart annotation	Enables chart annotations to be visible. Options are: <ul style="list-style-type: none"> ■ None ■ Alarms ■ Alarms & Operator Messages
Chart divisions	The major and minor chart divisions.
Trace pointers	Toggles the trace pointers on/off.
Screen interval	The amount of data shown on the screen.
Trace width	The width of each trace in pixels (1 to 3).

6.6.2 Ranges

Fields	Description
Chart Low Chart High	The chart high/low scale for each stream

6.6.3 Archive

Used to configure the data that is to be recorded on the SD card – see Section 9, page 51.

When external archive media contains approximately 300 files, its read/write performance becomes too slow, archiving is stopped automatically and the  icon is displayed alternating with the  icon. In this condition, data continues to be recorded to internal memory. Replace the SD card with an empty card to prevent loss of unarchived data.

Fields	Description
Archive file format	channel data file enable.
Archive file enables	<p>At least one of these options must be selected for data to be archived automatically to an SD Card. A dialog box is displayed showing the log files that are to be recorded:</p> <ul style="list-style-type: none"> ■ Text format file containing the stream data. ■ Binary format file containing stream data. ■ Alarm event log file enable (*.e) ■ Audit log file enable (*.a)
New file interval	<p>Available only if 'Wrap' is set to 'Off' and text format is selected. The interval that text format stream data files are created. Options are:</p> <ul style="list-style-type: none"> ■ Off ■ Hourly ■ Daily ■ Monthly
Wrap	<p>If set to 'On', the oldest archived data on the SD card is deleted automatically when the SD card approaches its maximum capacity.</p> <p>If set to 'Off', archiving stops when the SD card is full. The analyzer continues to store data internally – see Section 9, page 51. When an empty SD card is inserted, archiving continues from the point that the last archive was made.</p>

6.7 Communications

There are four tabs in the 'Communications' modules screen:

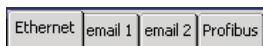

6.7.1 Ethernet

Configures the way in which the analyzer can be accessed via an Ethernet network – see Appendix D on page 90.

Fields	Description
IP-address	The IP-address to be assigned to the analyzer. The IP address is used by the TCP/IP protocol to distinguish between different devices. The address is a 32 bit value expressed with four values (0 to 255), each separated by a period (.).
Subnet mask	The subnet mask is used to indicate which part of the IP address is for the network ID and which is for the host ID. Set each section that is part of the network ID to 255. For example, 255.255.255.0 indicates first 24 bits are for the network ID.
Default Gateway	The IP address for the 'Default gateway' (for example, router, switch) required to communicate with other networks. The default setting is '0.0.0.0'
FTP user 1 to FTP user 4	Enables up to four users to access the analyzer via the internet. A dialog box is displayed with four options: <ul style="list-style-type: none"> ■ User name – the name of user granted FTP access (up to 12 characters). ■ Password – the password required for FTP login (up to 12 characters). ■ Access Level – toggles between 'Full' or 'Read-only' access. ■ Remote Operation – toggles between 'None', 'Operator' or 'Configuration'. <p>Note. If a user is given full access via FTP, that user is able to select from the saved configuration files in the analyzer.</p>

6.7.2 E-mail 1 and E-mail 2

The analyzer can be configured to send emails to a maximum of 6 recipients in response to certain events. The addressees can all subscribe to the same SMTP server or the analyzer can be configured to send emails via 2 different SMTP servers to a maximum of 3 addressees per server.

Up to 10 independently configurable triggers may be enabled to generate an email when the selected source becomes active. When a trigger source becomes active, an internal 1 minute delay timer is started. At the end of that minute, an email is generated that includes, not only the event that initiated the delay timer, but every other event that occurred during the delay period together with any enabled reports. The data returned in the email therefore reflects the real-time alarm state at the time the email was generated, not the state when the first trigger source became active.

Each email sent includes a link to the analyzer's embedded web server, enabling the analyzer's data and status to be viewed remotely using an internet browser on a PC.

Fields	Description
SMTP Server IP Address	The IP address of the SMTP server through which e-mails are to be routed.
Recipient 1 to Recipient 3	The e-mail address of recipient 1 to 3.
Inverted Triggers	The option to invert triggers 1 to 6.
Trigger 1 to 10	<p>The trigger for an e-mail message to be sent. A dialog box is displayed with three options:</p> <ul style="list-style-type: none"> ■ None – no triggers are set. ■ Archive state – a dialog box is displayed with six options: <ul style="list-style-type: none"> – Archive media not present – Too many files on the archive media – Archive media 100 % full – Archive media 80 % full – Archive media present – Archive on-line ■ Event group – A dialog box is displayed with nine options: <ul style="list-style-type: none"> – Solutions (reagent, cleaning solution, secondary solution is low or out) – Samples (out of one or more samples) – Optics (faulty optics) – Temperatures (control block/electronics out of limits) – Power (excessive current) – Calibration (factor/offset error or missed calibration) – Hardware (temperature sensor, analog-to-digital converter 1 to 3 failures) – Service (service due/media card full) – Alarm Relays (alarm relay active)

6.7.3 Profibus

Refer to separate Profibus manual – IM/AZT6PBS.

6.8 Commissioning

Note. Access to the Commissioning Level is prevented by an Internal Security Switch. The switch is, by default, set to 'Disabled' and should be set to 'Enabled' only if the measurement parameter or number of streams is to be changed. For further information on the function of the Internal Security Switch, refer to Section 6.1.4, page 28.

There is one tab in the Commissioning screen:



6.8.1 Setup

Fields	Description
Instrument type	The parameter to be measured by the analyzer. The options are: <ul style="list-style-type: none"> ■ Aluminium Monitor ■ Ammonia Monitor ■ Iron Monitor ■ Manganese Monitor ■ Manganese LR Monitor ■ Phosphate Monitor ■ Colour Monitor
Streams Fitted	The number of streams to be measured by the analyzer; 1, 2 or 3.
Serial Number	The serial number of the analyzer.
Mode of Operation	Options are: <ul style="list-style-type: none"> ■ Normal Run Mode ■ Demonstration Mode ■ Test Mode
Clear NonVol	Select 'Yes' to clear the analyzer's non-volatile memory.
Dilution Point	

7 Logging

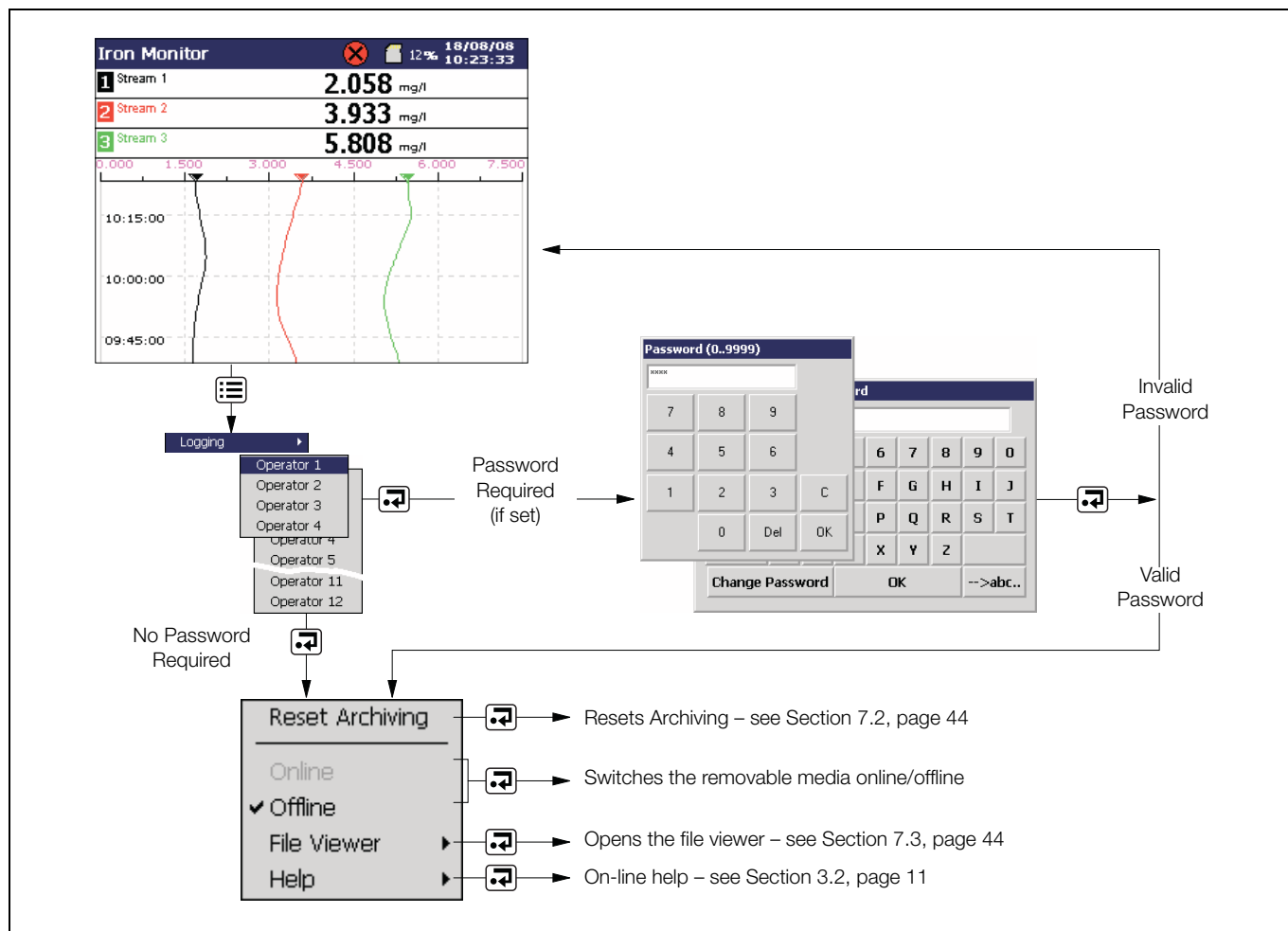

Fig. 7.1 Recording and Archiving

Data recorded in the analyzer's internal memory can be archived to a removable Secure Digital (SD) card media. The analyzer records **all** data continuously to its internal memory and keeps track of which data has been archived.

Note. ABB's DataManager software can be used to store and view data archived from the analyzer.

Caution. Electrostatic precautions for SD cards.

To avoid potential damage or corruption to data recorded on an SD card, take care when handling and storing the card. Do not expose the card to static electricity, electrical noise or magnetic fields. When handling the card take care not to touch any exposed metal contacts.

Sample data can be saved to removable media as either binary-encoded or comma-separated files.

Additional files can also be archived:

- Alarm event log data
- Audit log data
- Configuration files
- Screen capture images

The measured value is logged at 5 minute intervals.

Approximate durations for continuous recording of 3 streams are shown in Table 7.1 (internal storage), Table 7.2 (external text format files) and Table 7.3 (external binary format files).

Storage capacity onto internal (Flash) memory:

Capacity	300 s
8 Mb	3 years

Table 7.1 Internal Storage Capacity (3 Streams)

External (archive) capacities for text format files:

Sample Rate	128 Mb
300 seconds	>10 years

Table 7.2 Text Formatted Archive Files (3 Streams)

External (archive) capacities for binary format files:

Sample Rate	128 Mb
300 seconds	>10 years

Table 7.3 Binary Formatted Archive Files (3 Streams)

7.1 SD Cards

There are two methods of archiving to an SD card:

■ An SD card is kept in the analyzer

Data is copied automatically to the SD card at set intervals. The SD card is then swapped periodically for an empty one.

Depending on how the configuration has been set, data is added either to the card until it is full and then stops archiving or the oldest data on the SD card is overwritten by the newest.

Note. To set up the analyzer to archive data to an SD card automatically – see Section 6.6.3, page 38.

It is advisable to back-up critical data stored on an SD card regularly. The analyzer's internal memory provides a buffer for the most recent data so if data stored on an SD card is lost, it can be re-archived – see Section 7.2, page 44.

■ Data is copied to an SD card when required

An SD card is inserted into the analyzer and a prompt is displayed asking the user to select the unarchived data to be copied – see Section 12, page 56.

7.1.1 SD Card Insertion/Removal

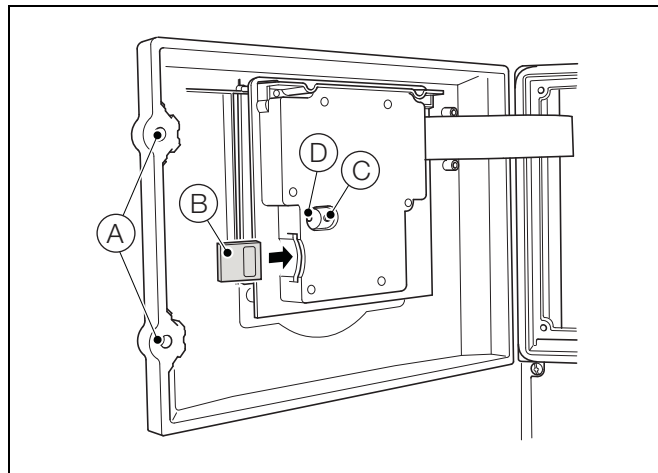
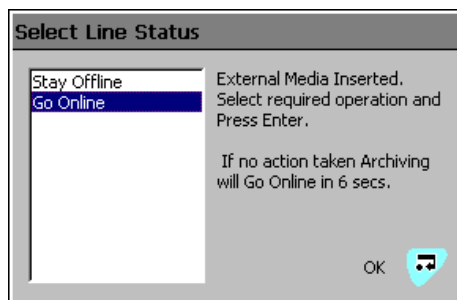

Fig. 7.2 SD Card Removal

To access the SD Card:

1. Ensure the analyzer is offline.
2. Use a large flat-headed screwdriver to release the two door catches (A).
3. Open the door and insert the SD card (B).
The red LED (D) is illuminated when the SD card is in use by the analyzer.
4. To remove the SD card, if the red LED is illuminated, press the button (C) and wait until the LED goes out.
5. Remove the SD card from the socket. The SD card can then be inserted into an appropriate card reader attached to a PC and the data downloaded.

When an SD card is inserted and there is <1 day (Binary format) or <1 hour (Text format) of data in internal memory, a dialog box is displayed giving the user the choice of putting the media on-line or remaining offline. If no selection is made within 10 seconds, the media card is placed on-line automatically:



Note. Data stored in the internal memory buffer can still be transferred to the archive media when the archive media is placed on-line again (providing it is not off-line so long that the un-archived data in the internal memory is overwritten).

When an external archive media card is inserted and there is >1 day (Binary format) or >1 hour (Text format) of data in internal memory, a dialog box is displayed prompting the user to select either the data to be archived or remain off-line:

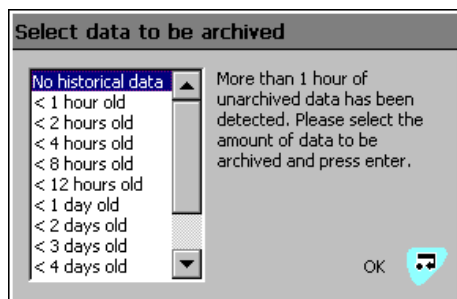

Select the data to be archived and press the  key. A progress bar is displayed:

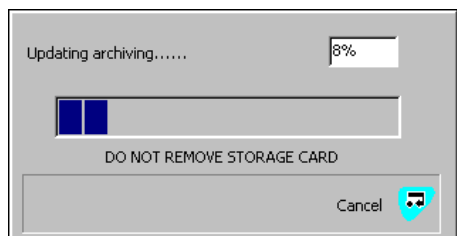

The files are copied to the SD Card.

7.1.2 External Media Status Icons

The status of external media is indicated by icons displayed in the Status Bar – see Table 2.1, page 8.

For a list of Status icons, refer to Section 12.3.3, page 62.

7.2 Reset Archiving

If 'Reset Archiving' is selected, all data in the internal memory is re-archived to external media.

Note. Ideally, insert a blank media storage card before selecting this function.

To re-archive data:

1. Insert an SD card, with sufficient free space, into the analyzer.
2. Select 'Off-line' in the menu.
3. Select 'Reset archiving' in the menu.
4. Select 'On-line' in the menu.
5. Select the data to be archived if >1 hour (Text format) or >1 day (Binary format) of data in internal memory and press the  key.

7.3 File Viewer

A prompt is displayed providing the option to view either internal or external files (if an SD card is present).

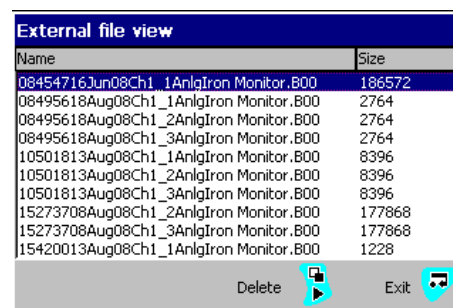

Use the  and  keys to scroll up and down the screen.

If viewing files on the SD card, files can be deleted by highlighting a file and pressing the  key.

7.4 Archive File Types

Archive files are created in text format or binary format, depending on the format selected at the 'Archive File Format' parameter – see Section 6.6.3, page 38.

7.5 Text Format Data Files

Text format archived data is stored in a comma-separated value format and can be imported directly into a standard spreadsheet, for example, Microsoft® Excel (as shown in Figs. 7.3 and 7.4).

The files can also be saved in ASCII text format.

Alternatively, the data can be analyzed graphically in detail on a PC using ABB's DataManager data analysis software.

	A	B	C	D	E	F	G	H	I	J
1	Instrument tag	Aluminium Monitor	Serial Number		Date format	0	Instrument type			
2	Configuration file		15_12_12 170908 Aluminium Monitor.cfg							
3	Tag		Data							
4										
5	CH1.1	Stream 1		No. dp's =	3	Eng lo =	0	Eng hi =	0.4	mg/l
6	CH1.2	OFF								
7	CH1.3	OFF								
8										
9	Date	Time	Stream 1							
10			CH1.1	CH1.2	CH1.3					
11			mg/l							
12			instant	OFF	OFF					
13	17/09/2008	07:12:47							0.112	
14	17/09/2008	07:17:47							0.104	
15	17/09/2008	07:22:47							0.104	
16	17/09/2008	07:27:47							0.104	
17	17/09/2008	07:32:47							0.104	

Fig. 7.3 Example of Text Format Channel Data File

	A	B	C	D	E	F	G	H
1	Instrument tag	Aluminium Monitor	Serial Number		Date format	0	Instrument type	Aztec 600
2								
3								
4	Date	Time	Type of event	Description	Op id			
5								
6								
7	15/09/2008	12:27:16	Power recovery					
8	15/09/2008	12:28:10	Monitor Stopped					
9	15/09/2008	12:37:55	Config changed		Operator 1			
10	15/09/2008	13:01:00	Calibration Passed					
11	15/09/2008	13:01:00	OD Low = 0.056	OD High = 0.545				

Fig. 7.4 Example Text Format Audit Log File

7.5.1 Text Format Stream Data Filenames

Text format stream data files can be configured to contain data gathered over a predefined period of time (selected at the 'New File Interval' parameter) – see Section 6.6.3, page 38. The 'Analyzer Tag' is set in the configuration – see Section 6.1.1, page 26.

Note. The time and date are formatted according to the date format set in 'Common Configuration' – see Section 6.1.3, page 27.

Once configured, the filenames for each archive file are assigned automatically.

New File Interval	Filename
Hourly	<hour> <day, month, year> <filename tag>.d00
Daily	<day, month, year> <filename tag>.d00
Monthly	<month, year> <filename tag>.d00
None	<filename tag>.d00

Table 7.4 Text Format Stream Data Format

Filename extensions are assigned according to the data type archived, as detailed in Table 7.5.

Data	Text Format File Extension
Stream data	*.D**
Alarm Event Log data files containing the historical record of the alarm events related to the stream(s) plus the history of any operator messages – see Section 7.5.3, page 47.	*.E**
Audit Log data files containing the historical entries from the audit log – see Section 7.5.3, page 47.	*.A**

Table 7.5 Text Data Filename Extensions

In addition to creating new stream data files according to the 'New File Interval', they are also created in the following circumstances:

- If the analyzer's power is lost then restored.
- If the analyzer is taken offline and the archive media removed, replaced or refitted.
- If the analyzer's configuration is changed.
- If one of the current files exceeds the maximum permissible size.
- When the daylight saving period starts or ends.

Note. The analyzer's internal clock can be configured to adjust automatically at the start and end of 'Daylight Saving Time' periods.

When one of the above conditions occurs, new stream data files are created for each enabled group and the file extension index on each new file is incremented by one from the previous file.

Example: If the original file had an extension of .D00, after one of the above events a new file is created with the same filename but an extension of .D01.

7.5.2 Text Format Stream Data – Example Filenames

New file interval set to Hourly, Filename tag set to Process Group 1; date is 10th October 2007; Channel data and alarm event log files only enabled:

9:00 am new file created in which all channel data recorded between 9:00 and 9:59:59 is archived in the following file:

09_00_10 Oct07_Process_Group_1.d00

09:12am Power interrupt occurs

09:13am Power restored and new file created:

09_00_10 Oct07_Process_Group_1.d01

10:00am New file created in which all data recorded between 10:00 and 10:59:59 is archived.

10_00_10 Oct07_Process_Group_1.d00

Note.

Hourly files start exactly on the hour.

Daily files start at 00:00:00.

Monthly files start at 00:00:00 on the first of the month.

7.5.3 Text Format Log Files (Audit and Alarm Log)

Alarm Event logs for each process group and the Audit log are archived into individual files.

The filenames are formatted as shown in Table 7.6.

Log File	Filename
Alarm Event	<hour min> <day, mm, yy> <process group tag>.e00
Audit Log	<hour min> <day, mm, yy> <instrument tag>.a00

Table 7.6 Text Format Log File Format

If one of the archive log files becomes full (>64000 entries) a new file is created with an extension incremented by 1, for example: a01, e01.

New text format log data files are also created when the daylight saving period starts.

7.5.4 Daylight Saving

Files containing data generated during the daylight saving period have '~DS' appended to the filename.

Start of daylight saving period

A daily file is started at 00:00:00 on 30th March 2007 filename:

30Mar07AW633.D00

Summertime starts at 2:00am on 30th March 2007 and the clock changes automatically to 3:00am.

The existing file is closed and a new file is created filename:

30Mar07AW633~DS.D00

The file '30Mar07AW633.D00' contains data generated from 00:00:00 to 01:59:59.

The file '30Mar07AW633~DS.D00' contains data generated from 03:00:00.

End of daylight saving period

A daily file is started at 00:00:00 on 26th October 2007 filename:

26Oct07AW633~DS.D00

Summertime ends at 3:00am on 26th October 2007 and the clock changes automatically to 2:00am.

The existing file is closed and a new file is created filename: 26Oct07AW633.D00

The file '26Oct07AW633~DS.D00' contains data generated from 00:00:00 to 02:59:59.

The file '26Oct07AW633.D00' contains data generated from 02:00:00.

7.5.5 Text Format Data Verification and Integrity

When text format data is saved to the archive media it is checked automatically to verify that the data stored on the media matches exactly what is stored in the internal memory.

7.6 Binary Format Data Files

Binary format archived data is stored in a secure binary encoded format. A separate file is created for each recording channel. The log data is stored in an encrypted text format.

The files can be read on a PC using ABB's DataManager data analysis software package.

7.6.1 Binary Format Data Filenames

When the 'Archive file format' parameter is set to 'Binary format', the 'New File Interval' parameters (see Section 6.6.3, page 38) are disabled and binary format filenames are created with the content – see Table 7.7.

Data Type	Filename Content
Stream Data	<Start Time HHMMSS> <Start Date DDMMYY> Ch<Group><Channel><analyzer tag> e.g.: 14322719May08Ch1_2Final Water3
Alarm Event Log Data	<Start Time HH_MM> <Start Date DDMMYY> <Process Group Tag> e.g.: 14_3219May08Final Water5
Audit log Data	<Start Time HH_MM> <Start Date DDMMYY> <Instrument Tag> e.g.: 14_3219May08Final Water3

Table 7.7 Binary Format Data Filenames

Filename extensions are assigned according to the data type archived – see Table 7.8.

Data	Binary Format File Extension
Stream data	*.B**
Alarm Event Log data files – the historical record of the alarm events related to the stream(s) plus the history of any operator messages	*.EE*
Audit Log data files – the historical entries from the audit log	*.AE*

Table 7.8 Binary Format Data Filename Extensions

7.6.2 Binary Format Stream Files

A new binary format archive file is created under the following conditions:

- When the current file for a stream does not exist on the media card.
- When the maximum permissible size (5 Mb) of the existing data file is exceeded.
- When the recording channel's configuration is changed.
- When the daylight saving period starts or ends (stream data files generated during the daylight saving period have -DS appended to the filename).

Note. The analyzer's internal clock can be configured to adjust automatically at the start and end of 'Daylight Saving Time' periods.

Filename Examples

Example 1 – Start of daylight saving period:

Archiving is started at 01:45:00 on 30th March 2008 – filename: 01450030Mar08Ch1_1AnlgAW633.B00.

Summertime starts at 2:00am on 30th March 2008.

The clock changes automatically to 3:00am.

The existing file is closed and a new file is created –filename: 03000030Mar08Ch1_1AnlgAW633~DS.B00.

The file '01450330Mar08Ch1_1AnlgAW633.B00' contains data generated from 01:45:00 to 01:59:59 (before summertime starts).

The file '03000030Mar08Ch1_1AnlgAW633~DS.B00' contains data generated from 03:00:00 (after summertime starts).

Example 2 – End of daylight saving period:

Archiving is started at 00:15:00 on 26th October 2008 – filename: 00150026Oct08Ch1_1AnlgAW633~DS.B00.

Summertime ends at 3:00am on 26th October 2008.

The clock changes automatically to 2:00am.

The existing file is closed and a new file is created –filename: 02000026Oct08Ch1_1AnlgAW633.B00.

The file '00150026Oct08Ch1_1AnlgAW633~DS.D00' contains data generated from 00:15:00 to 02:59:59 (before summertime ends).

The file '02000026Oct08Ch1_1AnlgAW633' contains data generated from 02:00:00 (after summertime ends).

7.6.3 Binary Format Log Files

A new binary format log file is created under the following conditions:

- When an existing (valid) binary file does not exist on the media card.
- When the maximum size (64000 entries) is exceeded.
- When the daylight saving period starts or ends.

7.6.4 Daylight Saving

Files containing data generated during the daylight saving period have '~DS' appended to the filename – see Section 7.5.4, page 47 for examples of appended filenames.

Note. Binary format archive files created during the daylight saving period (summertime) are compatible with the database feature of Version 5.8 (or later) only of ABB's DataManager data analysis software package.

7.6.5 Binary Format Data Verification and Integrity

When data is saved to the archive media it is checked automatically to verify that the data stored on the media matches exactly what is stored in the internal memory.

Each block of data in the channel data files has its own data integrity check. This enables the integrity of the data stored on the external media card to be verified when it is viewed using ABB's DataManager software package.

The log files also contain built-in integrity checks enabling the integrity of the data to be verified by the DataManager software.

8 Chart Functions

Note. The 'Chart Functions' menu can be accessed only from the 'Chart View' screen.

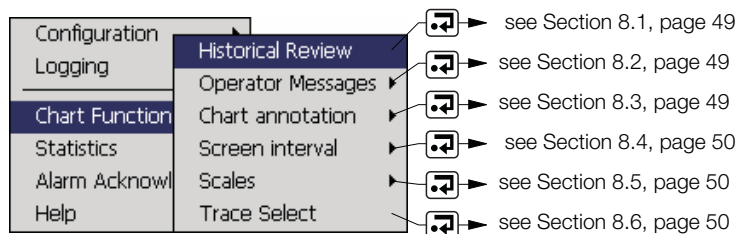



Fig. 8.1 Chart Functions

8.1 Historical Review

Note. While in Historical Review mode:





- Invalid historical data (for example, when recording has stopped) is denoted by '- - -' in the digital indicator.
- Operator messages generated are added to the alarm event log at the present time, not the time indicated by the cursor.
- All data stored in the analyzer's internal memory can be viewed.
- If daylight saving is enabled (see Section 7.5.4, page 47) **and** the selected 'Goto' target date/time is within the daylight saving period, 'Daylight Saving' is displayed on the dialog box.



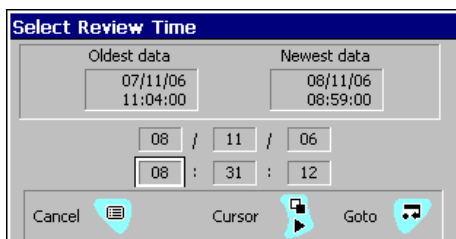

Enables a historical view of the chart. While in the 'Historical Review' screen an animated  icon is displayed at the top of the screen. The analyzer exits 'Historical Review' mode automatically after 15 minutes if no key is pressed.

Selecting the 'Historical Review' menu item changes the screen to the history view – use the   keys to scroll up and down the screen.

Selecting the 'Historical Review' menu item a second time gives the option of either exiting the historical review or to go to a specified date/time:



Press the   keys to select the date/time and press the   keys to change the selected value.

To finish, press  or press  to escape without making any changes. The screen displays the chart at the selected date/time. Use the   keys to scroll up and down the screen.

8.2 Operator Messages

These are messages that can be used to annotate the chart. These can be selected from up to 24 pre-defined messages – see Section 6.1.6, page 31. Alternately, the messages can be user-defined.

Annotations can also be added remotely via the web – see Appendix D, page 90.

The annotation is added to the chart at the time it is entered. For example:

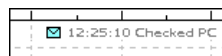

An entry is also included in the Alarm Event Log.

Note. Annotations added while in 'Historical Review' are added to the chart at the time of entry **not** on the chart as it is displayed on the screen.

8.3 Chart Annotation

Toggles any operator messages and/or alarms on/off.

8.4 Screen Interval

Used to control the amount of data displayed on the screen. A longer screen interval displays more data, a shorter screen interval displays data over a shorter time period. In both cases, the full trace is preserved by plotting the maximum and minimum samples for each display.

When a different screen interval is selected from this menu, it is retained only as long as the Chart View screen is displayed. To save a different screen interval (as the default for future use), select 'Configuration'/'Logging'/'Chart'/'Screen Interval', set the screen interval required and save the revised configuration on exit.

8.5 Scales

Selects the scale to be used. Up to three color-coded streams can be displayed simultaneously and each stream can have its own scale (to set the scale, see Section 6.2.2, page 32).

If 'Auto Scroll' is selected the scale for each enabled stream is displayed sequentially. The displayed scale is color-coded to match the stream. For example:

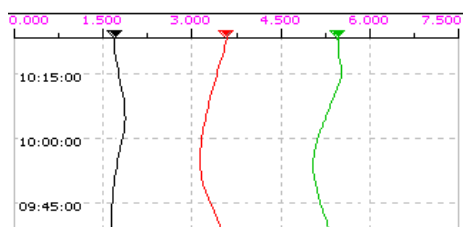

8.6 Trace Select

Selects which traces are displayed.

9 Operate

Note. The 'Operate' menu can be accessed only from the 'Indicator View' screen.

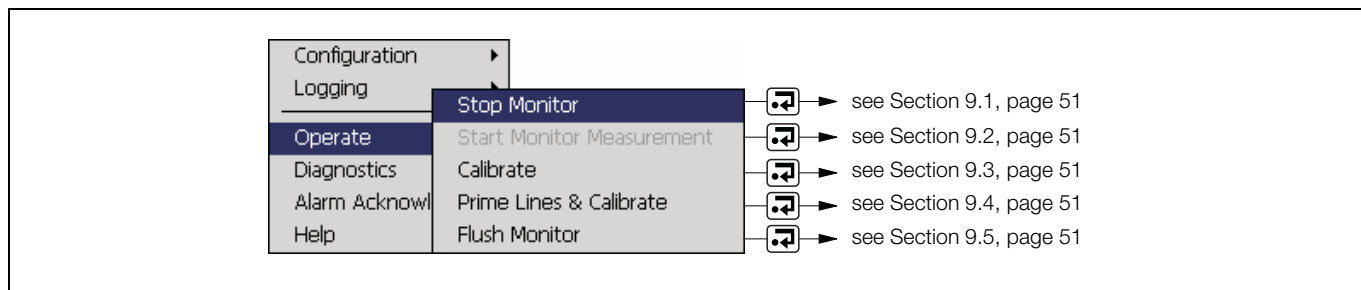

Fig. 9.1 Operate Menu

9.1 Stop Monitor

Select to stop the analyzer. When selected, the measurement cell is emptied and the analyzer waits in the reset position (piston down) awaiting a new command. The temperature of the measurement cell is maintained at the set level ensuring no warm-up delay when the analyzer is restarted.

9.2 Start Monitor Measurement

Select to start the analyzer. If the analyzer was switched off at the mains, or a fault had occurred, measurement does not start until the measurement cell reaches the operating temperature set during configuration – see Section 6.2.1, page 32. The message 'Temperature Stabilising' appears at the bottom of the screen until the cell is up to temperature.

If the analyzer has not been used for an extended period of time, allow it to operate for a few hours and then recalibrate.

The analyzer runs automatically until it is switched off.

9.3 Calibrate

A manual calibration can be performed at any time. It is not necessary to stop the analyzer.

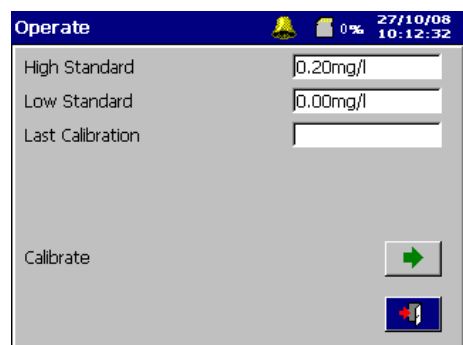

Highlight the [Green Arrow] button and press [Navigation Icon] to initiate calibration.

When calibration is complete, the measurement cycle begins automatically.

9.4 Prime Lines and Calibrate

When the reagents are changed, or the analyzer is either operated for the first time or operated following an extended period of shut down, prime the reagent and sample lines. The 'Prime' function draws in each reagent, sample and standard in turn, filling the lines and then pumping to waste. An automatic calibration is then started. After calibration the measurement sequence begins automatically.

If the analyzer is switched off at the mains without stopping operation via the menu, or if a power supply failure occurs, the analyzer starts the Prime Lines and Calibrate routine automatically when power is restored.

9.5 Flush Monitor

This facility mimics the prime routine but does not store or display measurement values.

The routine can be used **without** a prior calibration and is useful when the measurement parameter is changed, for example, from iron to aluminium.

When flushing is selected, this operation is continuous until stopped by the user or a different operation such as 'Calibration' is selected.

10 Diagnostics

Note. The 'Diagnostics' menu can be accessed only from the 'Indicator View' screen.

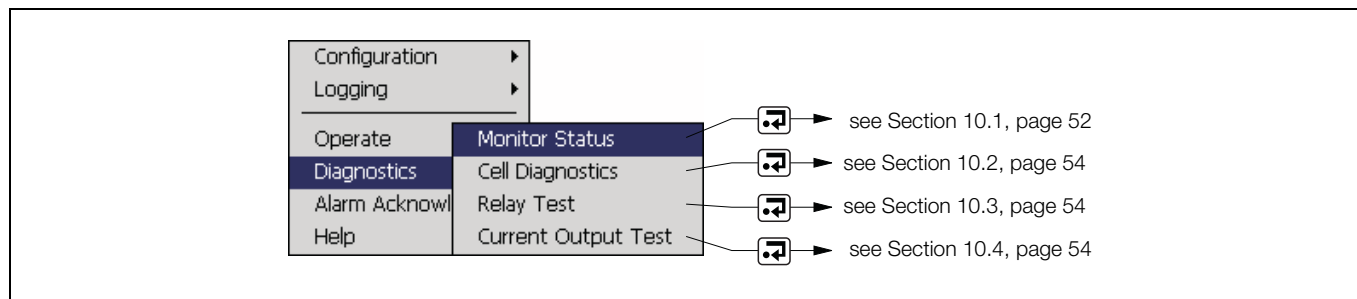
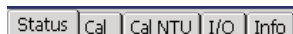

Fig. 10.1 User Diagnostic Screens

10.1 Monitor Status

There are five tabs in the Monitor Status screen:



10.1.1 Status

Fields	Description
Current State	Displays the current state of the analyzer (for example, Measuring, calibrating, off).
Current Step	An indication of what the analyzer is doing in 'real time'.
Measurement Complete	A 'real-time' indication of measurement cycle progress
Sample Concentration	The current estimated concentration, derived from the raw detector signal. This is displayed only after the addition of all reagents.
Detector mV	The raw signal from the analyzer detector (0 to 4095 mV).
LED Current	Displays the current of the LED.
Dilution Ratio(s)	The current dilution ratio applied to each of the measurement streams.
Cell Temperature	The current recorded cell temperature.

10.1.2 Cal

Fields	Description
Calibration State	Displays the standard currently being measured during the calibration cycle (for example, Measuring Low, Measuring High).
Percentage Complete	A 'real-time' indication of how far through a calibration is.
OD, Low/High	The measured Optical Density (OD) of the low standard and high standard of the previous calibration.
Current Value	The raw signal from the analyzer detector shown as a voltage (0 to 4095 mV) and also converted into a concentration value. This value is displayed only for the high standard and after the addition of all reagents.
Last Gradient	Displays the calibration gradient of the previous calibration.
Gradient Coefficient	The gradient coefficient is an indication of the difference between the calculated calibration gradient and an ideal calibration gradient stored within the analyzer. Any slight differences (due to temperature variations, reagent ageing etc.) are expected and 'calibrated out'. If there is a large variation, the analyzer fails calibration. The ideal coefficient =1, default fail criteria occurs when the coefficient is outside the range 0.4 to 1.6.
Time Last Cal.	The date and time of the previous calibration.

10.1.3 I/O

















Fields	Description
mA O/P 1 to 6	Displays the current mA output for each of the analogue outputs.
Sample 1 to 3	Displays the level sensor reading from the side sample pot (empty or OK).
Reagent 1 to 3	Displays the level sensor reading from the reagent level sensors (empty or OK).
DI	Displays the level sensor reading from the de-ionised water reagent sensor (empty or OK).
Standard	Displays the level sensor reading from the calibration standard reagent sensor (empty or OK).

10.1.4 Info

Fields	Description
Software Version	The version number of the software release.
OS	The version number of the Operating System.
HMI	The version number of the user interface code.
Head	The version number of the head control software.
Serial Number	The analyzer's serial number.

10.2 Cell Diagnostics

Cell Diagnostics enables the user to control the operation of the analyzer manually – bringing in reagents and sample etc. It also displays the detector output in real time giving an insight into how the analyzer is performing.

<p>Note.</p> <p>If this procedure is selected when the analyzer is in operation, a warning is displayed:</p> <div data-bbox="172 415 635 667" style="border: 1px solid gray; padding: 10px; margin: 10px auto; width: fit-content;"> <p style="text-align: center;">Warning</p> <p style="text-align: center;">The monitor is still in operation. Continuing will override normal monitor operation.</p> <div style="display: flex; justify-content: space-around; margin-top: 10px;"> Back Continue </div> </div>	<p>Note.</p> <p>Select Back and press  to return to normal operation. Select Continue and press  to continue to cell diagnostics. This stops the current analyzer operation:</p> <div data-bbox="858 445 1321 709" style="border: 1px solid gray; padding: 10px; margin: 10px auto; width: fit-content;"> <table style="width: 100%; border-collapse: collapse;"> <tr> <td style="padding: 2px;">Operation</td> <td style="padding: 2px;">Bring In</td> <td style="padding: 2px;"></td> </tr> <tr> <td style="padding: 2px;">Volume</td> <td style="padding: 2px;">1.00ml</td> <td style="padding: 2px;"></td> </tr> <tr> <td style="padding: 2px;">Port</td> <td style="padding: 2px;">Reagent 1</td> <td style="padding: 2px;"></td> </tr> <tr> <td style="padding: 2px;">Detector Voltage</td> <td style="padding: 2px;">0mV</td> <td></td> </tr> <tr> <td style="padding: 2px;">LED Current</td> <td style="padding: 2px;">4.67mA Colour</td> <td></td> </tr> <tr> <td style="padding: 2px;">Perform Operation</td> <td colspan="2" style="padding: 2px; text-align: center;">  </td> </tr> <tr> <td></td> <td colspan="2" style="padding: 2px; text-align: center;">  </td> </tr> </table> </div>	Operation	Bring In		Volume	1.00ml		Port	Reagent 1		Detector Voltage	0mV		LED Current	4.67mA Colour		Perform Operation					
Operation	Bring In																					
Volume	1.00ml																					
Port	Reagent 1																					
Detector Voltage	0mV																					
LED Current	4.67mA Colour																					
Perform Operation																						
																						

Fields	Description
Operation	Enables the user to bring in solutions, expel solutions or reset the pump.
Volume	Enables the user to specify the quantity of liquid (in ml).
Port	Enables the user to specify the port (and therefore liquid) to import. Only one port can be opened at any one time.
Detector Voltage	Displays the detector voltage (0 to 4095 mV) in real time.
LED Current	Displays the LED current in real time.

10.3 Relay Test

All of the alarm relays can be set individually or reset to check their operation.

Note. This procedure affects the analyzer relay functions and the analyzer **overrides** the normal state.

10.4 Current Output Test

Within the Current Output Test Screen the user is able to check the analyzer current outputs manually.

A calibrated ammeter is required for this test. Put the leads from the ammeter onto the two current output terminals on the I/O board – see Section 4.6.3, page 18.

Check that the value shown on the analyzer LCD is the same value shown on the ammeter.

Use the ▲ and ▼ keys to increase/decrease the milliamp value.

If the ammeter and analyzer do not agree it may be necessary to recalibrate the current outputs – see Section 6.5.2, page 36.

Note. This procedure affects the current outputs of the analyzer and the analyzer **overrides** their normal state

11 Statistics

Note. The 'Statistics' menu can be accessed only from the 'Chart View' screen.

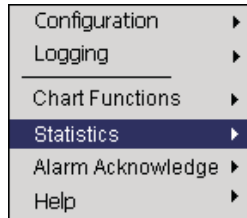
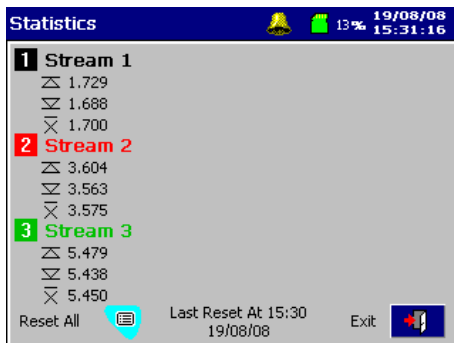



Fig. 11.1 Chart Functions

Displays the highest, lowest and mean values of the sample(s) since the analyzer was either switched on or the values were reset.



Press the  key to reset the values.

12 Diagnostic Information and Icons





12.1 Analyzer Diagnostic Information







The analyzer is programmed to display diagnostic messages to provide information on servicing requirements and any other conditions that develop during operation.

All diagnostic messages displayed on the analyzer are added to the analyzer's audit log.

Table 12.1 shows icon types, diagnostic messages and ON/OFF status for the relays.

Note. The diagnostic icons in the following table conform to NAMUR 107.

Diagnostic Icon	NAMUR Status
	Failure
	Check function
	Out of specification
	Maintenance required

Icon	Diagnostic message	Stop Relay	Attention Relay	Calibration Relay	Failure Relay
	Monitor in Service The analyzer is measuring correctly.	OFF	OFF	OFF	OFF
	20 Character User-defined Alarm Tag User-defined alarm message.	-	-	-	-
	Monitor Stopped Analyzer operation has been stopped by the user.	ON	OFF	OFF	OFF
	Monitor Off Analyzer operation has not been started or a failure has caused the analyzer to stop operation and switch off all services.	ON	OFF	OFF	OFF*
	Calibrating A calibration routine is being run.	OFF	OFF	ON	OFF
	A/D Error A hardware error exists on the main board. Power the analyzer down, wait for 10 seconds and power-up again. If the error still exists contact the local ABB representative	OFF	OFF	OFF	ON

*Relay status shows ON if a failure has caused the stoppage.

Table 12.1 Diagnostic Information, Relay Operations and Inhibits (Sheet 1 of 5)







Icon	Diagnostic message	Stop Relay	Attention Relay	Calibration Relay	Failure Relay
	<p>Calibration Failed</p> <p>The analyzer has failed calibration.</p> <ol style="list-style-type: none"> 1. Check that the reagents are of the correct type, connected correctly (Reagent 1 to valve R1 etc.) and are within their shelf life. If it is possible that the reagents have become contaminated replace them. 2. Check that the calibration settings are correct. 3. Check for any restrictions or blockages in the analyzer tubing or valve manifold. 4. Check that each reagent/sample is drawn into the measurement head correctly with no air bubbles. 5. Check the optical cell for any scratches. <p>If the error still exists contact the local ABB representative.</p>	OFF	OFF	OFF	ON
	<p>Calibration Failed</p> <p>The analyzer has failed calibration.</p> <p>If the Calibration Fail Event has been set to Attention from the default Fail, the analyzer continues to measure after a failed calibration using the last valid calibration.</p>	OFF	ON	OFF	OFF
	<p>Calibration Standard Empty</p> <p>The calibration standard bottle is empty.</p> <p>Replace the calibration solution.</p>	OFF	OFF	OFF	ON
	<p>Cleaning</p> <p>A clean routine is being run.</p>	ON	OFF	OFF	OFF
	<p>Critical Temperature Reached</p> <p>This alarm is initiated if the analyzer temperature rises above 60 °C (140 °F) during temperature control.</p> <ol style="list-style-type: none"> 1. Check that the ambient temperature limits have not been exceeded. 2. Contact the local ABB representative. 	OFF	OFF	OFF	ON
	<p>DI Empty</p> <p>The de-ionised water bottle is empty.</p> <ul style="list-style-type: none"> ■ Replace the de-ionised water. 	OFF	OFF	OFF	ON
	<p>Excessive Secondary Current in Electronics</p> <p>Too much current is being drawn by the electronics in the system; this causes the analyzer to go into automatic shutdown.</p> <ul style="list-style-type: none"> ■ Contact the local ABB representative. 	OFF	OFF	OFF	ON

Table 12.1 Diagnostic Information, Relay Operations and Inhibits (Sheet 2 of 5)





Icon	Diagnostic message	Stop Relay	Attention Relay	Calibration Relay	Failure Relay
	<p>Flow Failure, Stream n</p> <p>The analyzer can not detect any sample in stream 'n'.</p> <p>The indicated stream is excluded from the sampling sequence until the analyzer has detected that sample has returned.</p> <p>If there is sufficient flow to the analyzer:</p> <ol style="list-style-type: none"> 1. Check that float is located in the side sample pot and is unrestricted. 2. Check that end cap of the side sample pot is sufficiently placed to allow the magnetic float to be within the area of operation of the reed switch. 3. Check that the float switch lead is connected correctly to the interconnection board. 4. Check that the magnetic read switch is operating correctly. 	OFF	ON	OFF	OFF
	<p>Flushing</p> <p>The analyzer is in flushing mode.</p> <p>This facility carries out a continuous routine but does not store or display measurement values.</p> <p>The routine can be used without a prior calibration and is useful when a analyzer is swapped from one parameter to another.</p> <p>The analyzer remains in flushing mode until it is stopped.</p>	ON	OFF	OFF	OFF
	<p>Head Comms Failure</p> <p>Communication failure with Head Control Module.</p> <ol style="list-style-type: none"> 1. Check that the head chip is inserted correctly. 2. Contact the local ABB representative. 	OFF	OFF	OFF	ON
	<p>Heating Failure</p> <p>The analyzer has failed to reach operating temperature.</p> <p>This alarm is initiated if the analyzer temperature fails to rise 0.2 °C (32 °F) within 2 minutes during the temperature stabilizing routine.</p> <ol style="list-style-type: none"> 1. Check the integrity of the ribbon cable connecting measurement head to the interconnection board. 2. Contact the local ABB representative 	OFF	OFF	OFF	ON
	<p>Internal Communications Failed</p> <p>Communication failure between the main board and the display assembly.</p> <ol style="list-style-type: none"> 1. Check the ribbon cable connection to the main board. 2. Contact the local ABB representative 	-	-	-	-

Table 12.1 Diagnostic Information, Relay Operations and Inhibits (Sheet 3 of 5)







Icon	Diagnostic message	Stop Relay	Attention Relay	Calibration Relay	Failure Relay
	<p>Internal Electronics Temperature Too High/Low</p> <p>The internal temperature of the electronics enclosure is either too high or too low.</p> <ol style="list-style-type: none"> 1. Check that the ambient temperature limits have not been exceeded. 2. Contact the local ABB representative 	OFF	OFF	OFF	ON
	<p>LED Failure</p> <p>This alarm is initiated if the LED failed to adjust the detector voltage at the beginning of a calibration routine or, if during the piston reset routine, no light was sensed in the measurement cell even though the LED current is OK.</p> <ul style="list-style-type: none"> ■ Check that the LED and detector are connected correctly and working. 	OFF	OFF	OFF	ON
	<p>No Light at Detector</p> <p>This alarm is initiated during the piston reset routine if, after moving up and down twice, the measurement cell is continuously dark and no LED or motor fault is detected.</p> <ol style="list-style-type: none"> 1. Check that the LED and detector are connected correctly and working. 2. Check the measurement cell and piston. 	OFF	OFF	OFF	ON
	<p>No Valid Calibration</p> <p>There is no valid calibration stored within the analyzer memory.</p> <ul style="list-style-type: none"> ■ Calibrate the analyzer. 	ON	OFF	OFF	OFF
	<p>Non-Volatile Memory Error</p> <p>This message appears if there is a problem with either the display electronics or the main board memory.</p> <ul style="list-style-type: none"> ■ Power the analyzer down, wait for 10 seconds and power-up again. <p>If the error still exists contact the local ABB representative</p>	OFF	OFF	OFF	ON
	<p>Override Mode</p> <p>The analyzer is in Override Mode.</p> <p>Normal running has been overridden by the operator.</p> <p>The Override Mode is useful to check analyzer operation manually.</p> <p>The analyzer remains in Override Mode until it is stopped.</p>	ON	OFF	OFF	OFF

Table 12.1 Diagnostic Information, Relay Operations and Inhibits (Sheet 4 of 5)





Icon	Diagnostic message	Stop Relay	Attention Relay	Calibration Relay	Failure Relay
	<p>Piston Origin Fault</p> <p>This alarm is initiated during the piston reset routine if the piston comes down until it is dark, but then fails to find light when the piston is raised.</p> <ol style="list-style-type: none"> 1. Check that the LED and detector are connected correctly and working. 2. Check the measurement cell and piston. 	OFF	OFF	OFF	ON
	<p>Piston Reset Fault</p> <p>This alarm is initiated during the piston reset routine if light is always read at the detector, regardless of the piston position.</p> <ol style="list-style-type: none"> 1. Check that the LED and detector are connected correctly and working. 2. Check the measurement cell and piston. 	OFF	OFF	OFF	ON
	<p>Priming</p> <p>The analyzer is priming the tubing. The priming routine draws in each reagent, sample and standard in turn, filling the tubing and then pumping to waste.</p> <p>An automatic calibration starts when the priming routine is completed.</p>	ON	OFF	OFF	OFF
	<p>Reagent n Empty</p> <p>The indicated reagent bottle (n) is empty.</p> <ul style="list-style-type: none"> ■ Replace all reagents at the same time. 	OFF	OFF	OFF	ON
	<p>Temperature Stabilizing</p> <p>This message is displayed at startup and remains until the measurement head temperature has stabilized to within 1% of the programmed operating temperature.</p>	ON	OFF	OFF	OFF

Table 12.1 Diagnostic Information, Relay Operations and Inhibits (Sheet 5 of 5)

12.2 Alarm Acknowledge

To acknowledge a particular alarm, use the ▲ and ▼ keys to highlight it in the menu and press the ↵ key.

Note. Active unacknowledged alarms are identified by a flashing red alarm event icon. Active acknowledged alarms are identified by a continuous red alarm event icon.

To acknowledge all active alarms simultaneously, select 'All' and press the ↵ key.

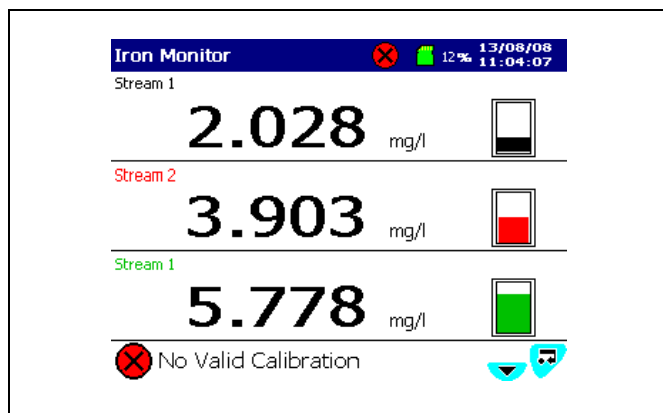

Fig. 12.1 Alarm Example

12.3 Audit Log and Alarm Event Log

The 'Audit Log' and 'Alarm Event Log' are used to display a list of events and alarms identified by icon, sequence number, date and time.

The 'Audit Log' provides an historical log of system activity and the 'Alarm Event Log' provides an historical log of all alarm events in the sequence they occurred.

When the number of entries in each log has reached 500, the oldest data is overwritten by the newest data. Entries are renumbered so that the number of the oldest entry is always 00.

Both logs are accessible from the chart view and bar view – see Section 2.1, page 8 for details of how to navigate to these logs.

Note. Use the ▲ and ▼ keys to scroll through log data.

12.3.1 Audit Log – Icons

Icon	Event
	Power failed
	Power restored
	Configuration changed
	File created
	File deleted
	Archive media inserted
	Archive media removed
	Archive media off-line
	Archive media on-line
	Archive media full
	System error/reset archiving
	Date/time or daylight saving start/end changed
	Security change
	FTP logon
	Information
	Failure – see Section 12.1, page 56
	Maintenance Required – see Section 12.1, page 56
	Out of Specification – see Section 12.1, page 56
	Check Function – see Section 12.1, page 56

12.3.2 Alarm Event Log – Icons

Note.

- A **flashing** red alarm icon indicates an active and unacknowledged alarm.
- A **continuous** red alarm icon indicates an active and acknowledged alarm.

Icon	Event
	High process alarm – active/inactive
	Low process alarm – active/inactive
	High latch alarm – active/inactive
	Low latch alarm – active/inactive
	High annunciate alarm – active/inactive
	Low annunciate alarm – active/inactive
	Clean-in-progress alarm – active/inactive
	In sample alarm
	Out of sample alarm
	Daylight saving start/end changed
	Alarm acknowledged
	Operator message

12.3.3 Status Icons

Note. Status icons are displayed in the Status Bar – see Fig. 2.1, page 8.

Icon	Event
	Historical review active
	External archive media on-line with % used indication
	External archive media off-line with % used indication
	External archive media not inserted (yellow flashing exclamation mark)
	Media update in progress. Do not remove media while this symbol is displayed
	External media 100% full, archiving stopped (green/grey icon, flashing white cross)
	Warning! Too many files (green icon – media online, grey icon – media offline)

13 Maintenance



Warning.

- Ensure personal protective equipment (PPE) such as **gloves** and **eye protection** are worn during any maintenance and that any spillages are cleaned-up using clean water.
- To familiarize yourself with handling precautions, dangers and emergency procedures, always review the Material Safety Data Sheets prior to handling containers, reservoirs, and delivery systems that contain chemical reagents and standards.
- Take care if cleaning any spillages and observe all relevant safety instructions – see Section 1, page 3.
- General cleaning of the instrument should be carried out using a damp cloth only, mild detergent can be used as a cleaning aid. Do not use Acetone or any organic solvents.
- Isolate electrical components before maintenance or cleaning.
- Observe all health and safety procedures for handling chemicals – see Section 1, page 3.

Aztec 600 analyzers are designed to be as maintenance-free as possible. The inherent product design and auto-calibrating features reduce the amount of maintenance required to only external cleaning (sample lines, etc.), changing the reagents and scheduled annual maintenance.

If followed correctly, the recommendations in this section help prolong the life and enhance the performance of the analyzer, thus reducing long-term operating costs.

Maintenance is divided into three categories:

- changing reagents
- regular visual checks
- annual scheduled maintenance

13.1 Changing Reagents

The reagent requirements and consumption rates are illustrated in appendix A of this manual.

To prevent the reagents from running out, check the consumption weekly to predict the optimum changeover time.

Use the following procedure when changing the reagents:

1. Stop the analyzer – see Section 9.1, page 51.
2. Check that the shelf life of the new reagent bottles is sufficient for the expected period of use.
3. Remove the caps from each bottle and change them one by one.

Caution.

- Avoid contamination of the solutions.
- When removing the reagent sensors ensure that no contact is made with the stem, including bare hands.
- Do not top-up solution bottles.
- Dispose of the used bottles and contents safely, according to national or local regulations. Analyzer performance relies heavily on the integrity of these solutions so it is very important to prepare, store and handle them with care.

4. Check to see whether the tubes are inserted correctly and the float switches are free to move.
5. When the level sensors are correctly in place, hand-tighten the bottle caps. This protects against the ingress of dust, water etc.
6. Select 'Prime lines and Calibrate' and press the  key.

Take care when storing the bottles. Ensure they are date stamped, used in strict rotation and not used after the expiry date.

13.2 Regular Visual Checks

Inspect the analyzer on a regular basis to ensure the correct functioning of the system and to check the integrity of the readings:

- Check for leaks, particularly around the sample and drain pipework connections.
- Confirm sample flow by checking delivery to the constant-head unit and effluent from the drain.
- Check liquid levels in the reagent, calibration and cleaning solution bottles.
- Inspect all tubing and liquid handling components for leaks and deterioration.
- Check for malfunction indications on the analyzer display.

13.3 Annual Maintenance

13.3.1 Annual Maintenance Schedule

Annual maintenance required:

- Replace piston seal
- Rotate glass cell
- Replace sample tubing

24-month maintenance required:

- Replace valve diaphragms
- Replace piston seal
- Replace glass cell
- Replace analyzer tubing

13.3.2 Annual Maintenance Kits

12-monthly and 24-monthly maintenance kits, that include all the components required for annual maintenance, are available for both single stream and multi stream analyzers.

Annual refurbishment ensures a high level of reliability from the analyzer.

Re-order the kit when used so that all the items are available throughout the following year's operation.

13.3.3 Maintenance Tools Required

- Small flat-bladed screwdriver
- No. 2 Pozidrive screwdriver
- 3 mm Allen key
- 4 mm Allen key









13.3.4 Replacing the Valve Diaphragms

Caution. Fluids from the analyzer are contaminated with acid from the reagents. Wear rubber gloves and apron and suitable eye protection when disconnecting the tubing to guard against splashes. Wipe up all spillages immediately.

1. Referring to Fig. 13.1:

- a. Check that anti-rotation device (A) is positioned at the bottom of the slot in the measurement cell top cover, indicating that the measurement cell piston is at the bottom of its stroke.

Note. Steps b to d are applicable only if the anti-rotation device is not positioned as shown.

- b. Press  and select 'Diagnostics' followed by 'Cell Diagnostics' from the 'Operator' menu.
- c. Use  and  to highlight the 'Operation' field and press  repeatedly to select 'Pump Reset'.
- d. Use  and  to highlight  and press  to reset the measurement cell piston to the bottom of its stroke and empty the measurement cell tube.

2. Isolate the analyzer from the power supply.

3. Turn off the sample feed to the side sample pot.

4. Referring to Fig. 13.1:

- a. Open the analytical section door and record the fitted position of each of the tubes connected to the valve manifold (B) to prevent reconnection errors.

Caution. During step b, do not allow any fluid draining from the tubes or the valve manifold assembly to come into contact with either the skin or any metallic/electronic parts of the analyzer. Some of the fluids are contaminated with acid from the reagents used in the analyzer. Wipe up all spillages immediately.

- b. Disconnect all tubes from the valve manifold.

- c. Remove the 3 M4 screws (C) securing the valve manifold to the analyzer, remove the valve manifold and place on a clean work surface.

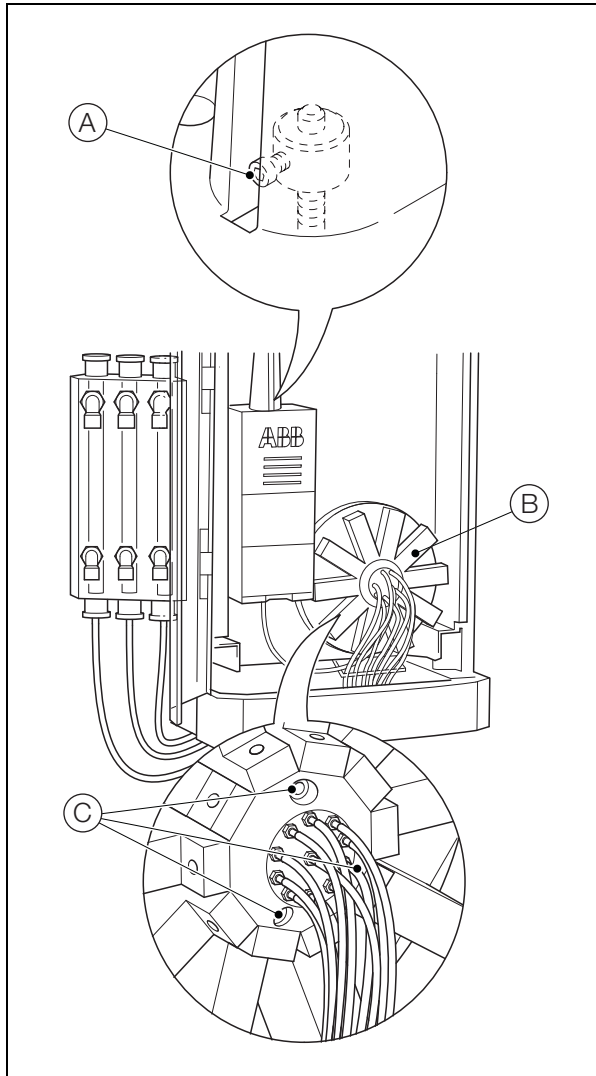

Fig. 13.1 Removing the Manifold

Note. During step 5, remove and refit the valves one at a time in the order given to ensure they are refitted in the correct position.

5. Referring to Fig. 13.2:

- a. Locate the waste valve (D), identified by an orange colored label (E) on the back of the valve.
- b. Remove the 2 M3 screws (F) securing the valve to the manifold and remove the valve. Discard the valve face gasket (G).
- c. Using a small screwdriver, depress the retaining clips (H) and remove the diaphragm seat (I).
- d. Turn the valve over and, taking great care not to lose spring (J), allow the diaphragm retainer (K), complete with washer (L), diaphragm (M) and spring (J) to fall out.
- e. Remove the diaphragm (M) from the diaphragm retainer (K) and discard.
- f. Fit the new Kalrez diaphragm, ensuring washer (L) remains in place below the diaphragm.

Note. All valves, except the waste valve, contain an EPDM diaphragm. The waste valve **must** be fitted with the KALREZ diaphragm.

- g. Ensuring spring (J) is in place in the hole in diaphragm retainer (K), insert the diaphragm retainer, complete with washer (L) and diaphragm (M) into the valve ensuring the spring remains in position.
- h. Press the diaphragm seat (I) into the valve body until the retaining clips (H) lock into place.

Note. The diaphragm seat retaining clips are different widths to ensure that the diaphragm seat fits in one position only.

- i. Fit the new Kalrez valve face gasket (G) into the recess in the diaphragm seat.

Note. All valves, except the waste valve, are fitted with an EPDM valve face gasket. The waste valve **must** be fitted with the KALREZ valve face gasket.

- j. Refit the valve (D) to the valve manifold and secure using the two M3 screws (F).

- k. Working in a clockwise or counter-clockwise direction, repeat steps b to j for the remaining valves, replacing the diaphragms and valve face gaskets with the new EPDM diaphragms and gaskets from the spares kit.

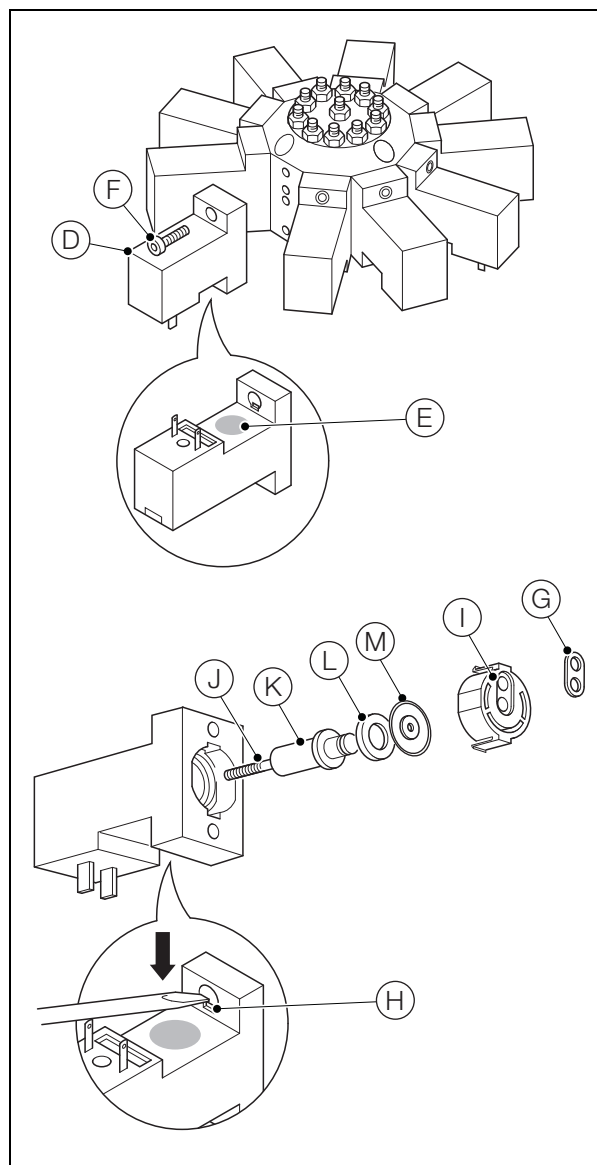

Fig. 13.2 Removing the Waste Valve

6. Referring to Fig. 13.3:
 - a. Locate the valve manifold over the off-set pegs (N) on the base plate, ensuring that the terminals on each valve engage in the sockets (O) on the base plate.
 - b. Secure the valve manifold to the base plate with the three M4 screws (P).

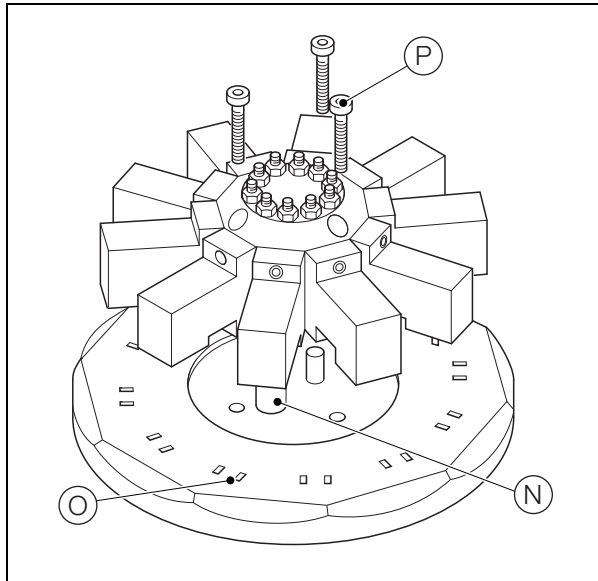

Fig. 13.3 Refitting the Valve Manifold

13.3.5 Replacing the Tubing

1. Referring to Fig. 13.4:
 - a. Note the routing of sample tube S1 (recorded in Section 13.3.4, step 4a).
 - b. Disconnect the tube from the base of the side sample pot (A) and discard.
 - c. Connect one end of the new sample tube to the side sample pot.
 - d. Route the tube as noted in step a and connect the other end to the S1 valve connector (B) on the valve manifold.
 - e. On multi-stream analyzers, repeat steps a to d for sample tubes S2 and S3.

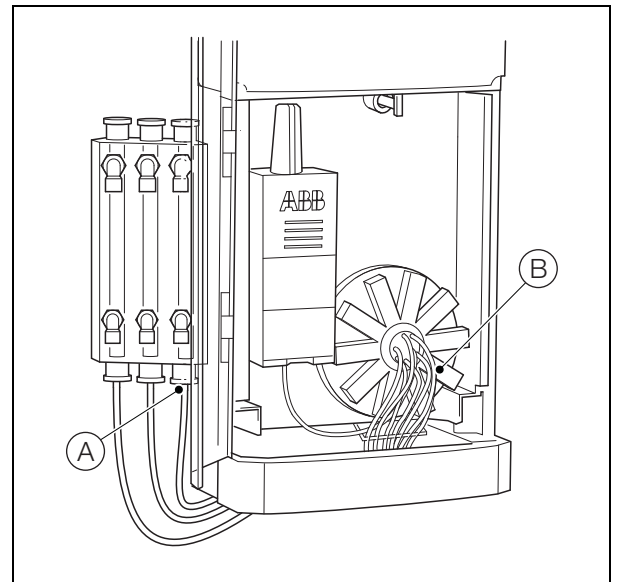

Fig. 13.4 Replacing Sample Tubes

Continued...

2. Referring to Fig. 13.5:
 - a. Note the routing of the waste tube (recorded in Section 13.3.4, step 4a).
 - b. Remove the tube from clip (C) and discard.
 - c. Route the new waste tube as noted in step a and connect it to the waste valve connector (D) on the valve manifold.

Caution. Ensure the correct tube is fitted
– AW630 371 (Tygon 3603)

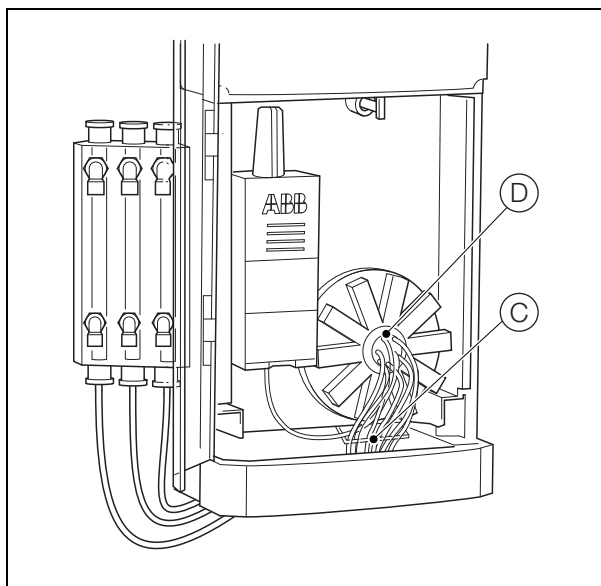

Fig. 13.5 Replacing the Waste Tube

3. Referring to Fig. 13.6:
 - a. Disconnect the interconnecting tube (recorded in Section 13.3.4, step 4a) from the connector (E) at the base of the measurement cell assembly and discard.
 - b. Fit the new interconnecting tube to the valve manifold center connection (F).

Do not connect the tube to connector (E) at this stage.

Caution. Ensure the correct tube is fitted:
– AW630 370 (Tygon 3603)

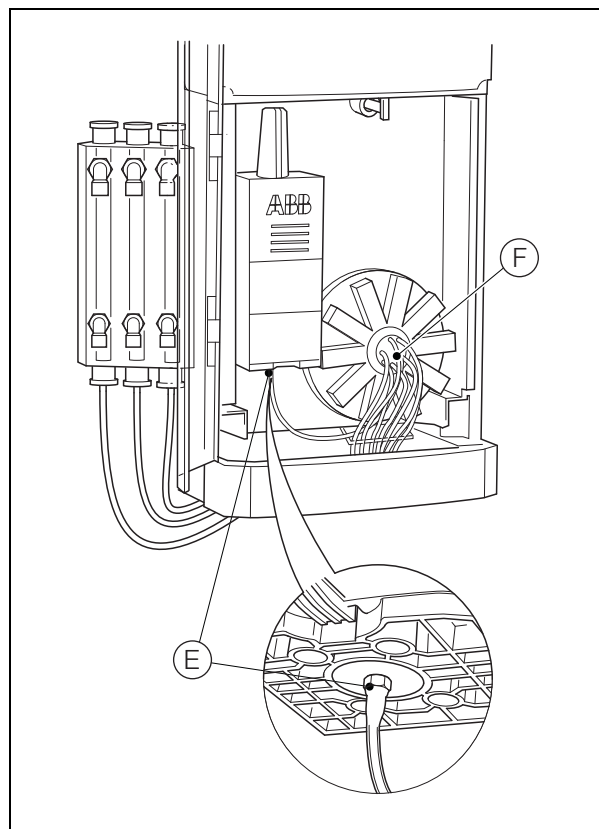

Fig. 13.6 Replacing Interconnecting Tube

4. Referring to Fig. 13.7:
 - a. Note the routing of reagent tube R1 (recorded in Section 13.3.4, step 4a).
 - b. Remove the spiral wrapping (G) from the reagent tube and level sensor cable (H).
 - c. Disconnect the tube from the level sensor (I) and withdraw the tube from the rubber boot (J).
 - d. Insert the new tubing through the rubber boot (J) and route the tubing into the analyzer as noted in step a. Connect the tubing to the R1 connector on the valve manifold (K).
 - e. Refit the spiral wrapping (G).
 - f. Cut the tubing to the required length and connect it to the level sensor (I).
 - g. Adjust the position of the spiral wrapping and rubber boot as required.
 - h. Repeat steps a to g for reagent tubes R2 and R3.

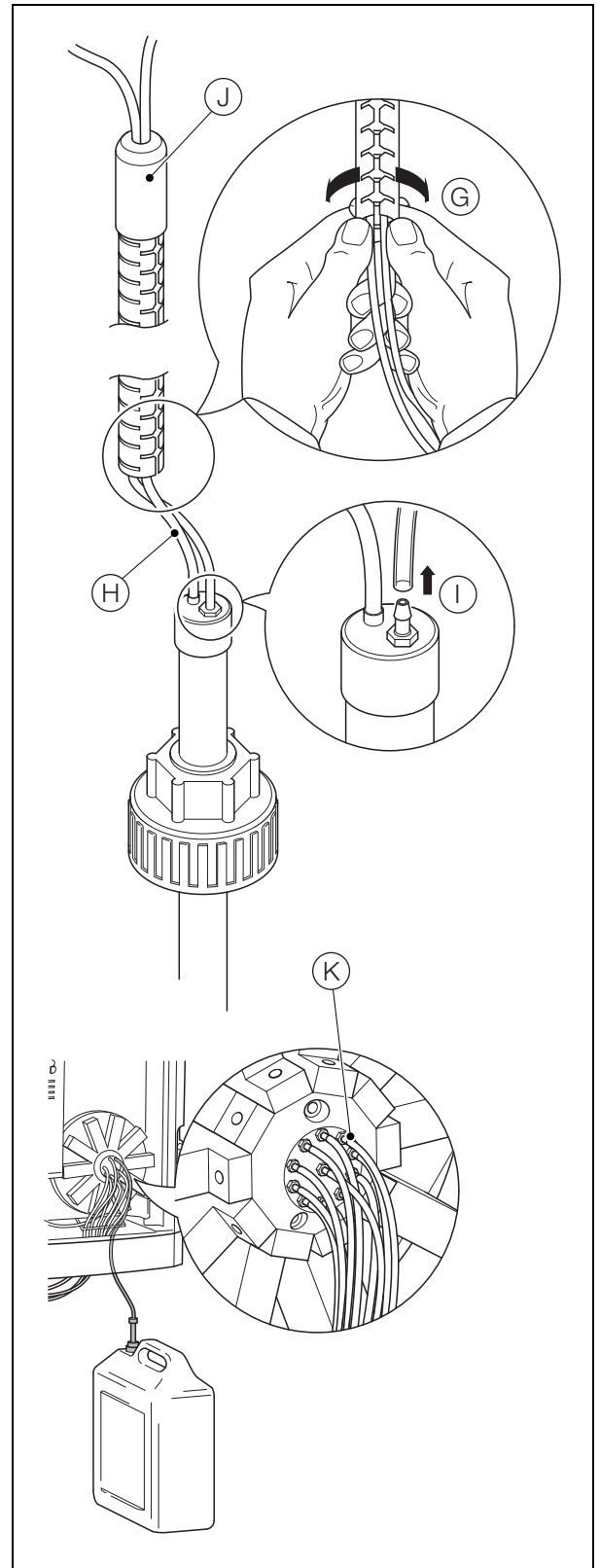

Fig. 13.7 Replacing Reagent Tube

13.3.6 Replacing the Piston Tube and Piston Assembly

1. Referring to Fig. 13.8, turn handle (A) 1/4 turn clockwise, pull the analytical section forward and allow it to rest against its stops.

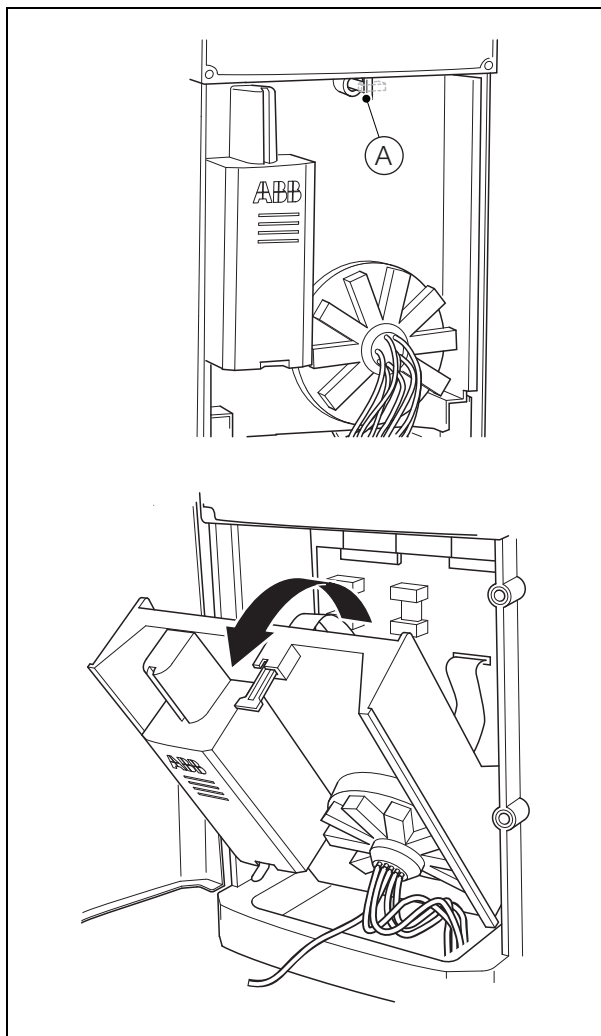

Fig. 13.8 Opening the Analytical Section

2. Referring to Fig. 13.9:
 - a. Disconnect the measurement cell ribbon cable (B) from the connector on the back of the measurement cell.
 - b. Remove the four M4 screws (C) and remove the measurement cell assembly.

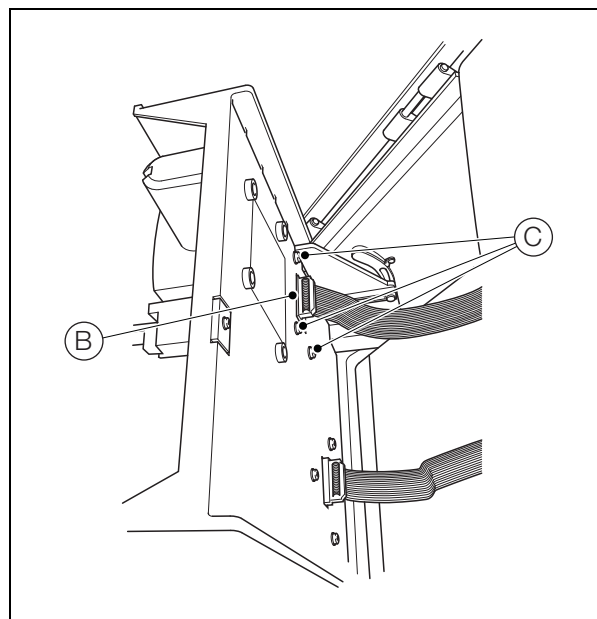

Fig. 13.9 Removing the Measurement Cell Assembly

3. Referring to Fig. 13.10, depress catch (D) and remove cover (E).

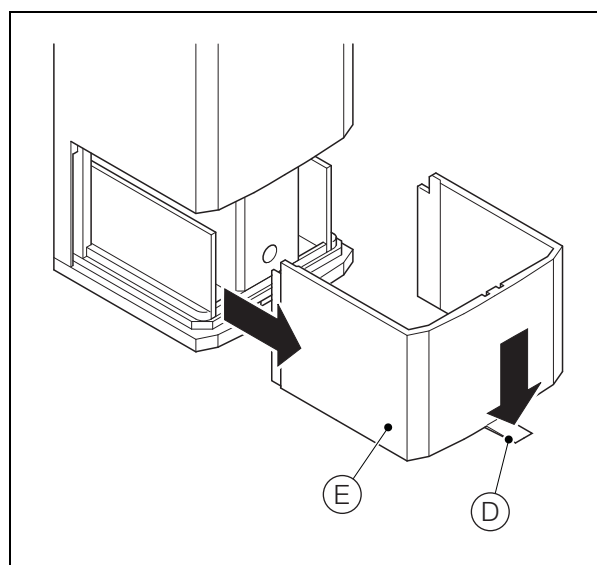

Fig. 13.10 Removing the Measurement Cell Cover

Caution. During step 4, do not allow any fluid from the measurement cell sample tube to come into contact with either the skin or any metallic/electronic parts of the analyzer. The fluid is contaminated with acid from the reagents used in the analyzer. Wipe up all spillages immediately.

4. Referring to Fig. 13.11,
 - a. Invert the measurement cell assembly, remove the four screws (F) and remove the base plate (G).
 - b. Remove the sample tube end face sealing cap (H) and remove seal (I). Discard the seal.
 - c. Remove all traces of fluid from inside the sample tube (J).

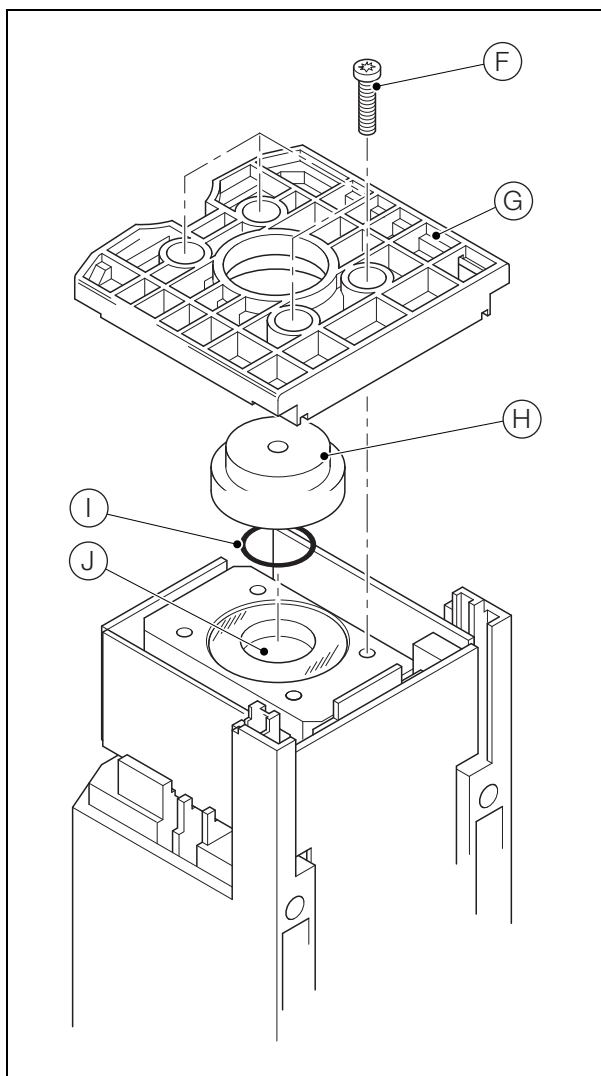

Fig. 13.11 Removing the Measurement Cell Base Plate

5. Referring to Fig. 13.12, remove the two screws (K) and remove the measurement cell top cover (L).

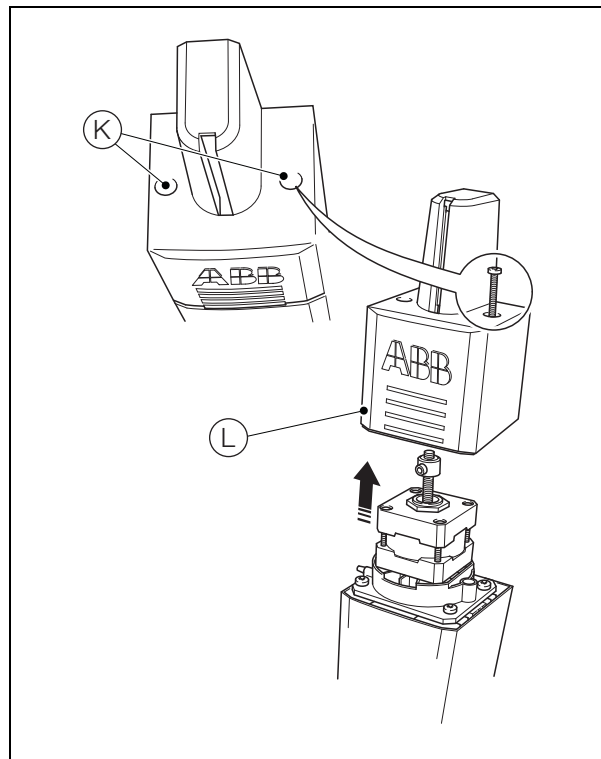

Fig. 13.12 Removing the Measurement Cell Top Cover

6. Referring to Fig. 13.13, disconnect the motor wiring plug (M).

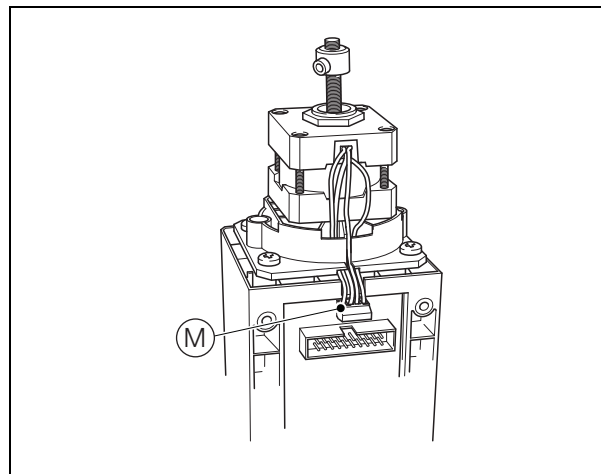

Fig. 13.13 Disconnecting the Motor

Continued...

7. Referring to Fig. 13.14, remove the four screws (N) and remove the motor and sample tube (O) from the lower half of the measuring cell.

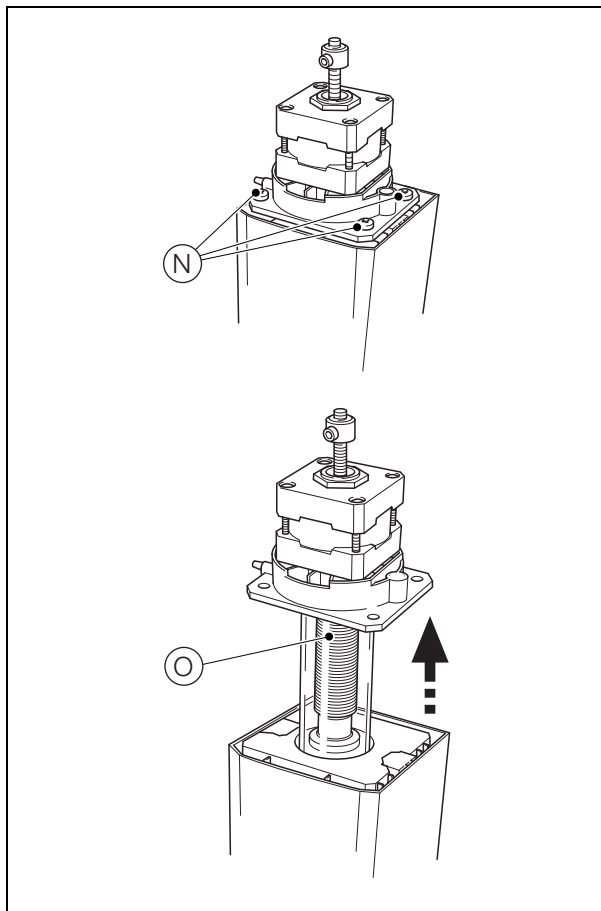

Fig. 13.14 Removing the Motor and Sample Tube

8. Referring to Fig. 13.15:
- Slide the sample tube (P) off the piston assembly (Q). Discard the sample tube.
 - Loosen retaining grub screw (R), unscrew the piston assembly (Q) from the piston shaft (S) and discard the piston assembly.
 - Lightly lubricate the new O-ring (T) and piston seal (U) with the silicon grease from the piston kit.
 - Fit the O-ring and piston seal to the new piston base (V).

- Insert the piston base, complete with seal and O-ring, into the new piston top (W) and secure loosely with the new piston cone adjusting screw (X) and spring washer (Y).

Do not tighten the piston cone adjusting screw at this stage.

- Insert the new piston assembly (Q) into the top of the new sample tube (P) and, holding the piston firmly, tighten the piston cone adjusting screw (X) until a continuous seal is achieved between the piston seal (U) and the sample tube (P).
- Remove the piston assembly from the sample tube and refit it to the piston shaft (S). Fit and tighten the new retaining grub screw (R).
- Remove O-ring (Z) from the base of the motor mounting plate and discard.
- Fit new O-ring (Z) ensuring it is located correctly in the groove in the base of the motor mounting plate.
- Fit the sample tube over the piston assembly and slide it up until it contacts O-ring (Z).

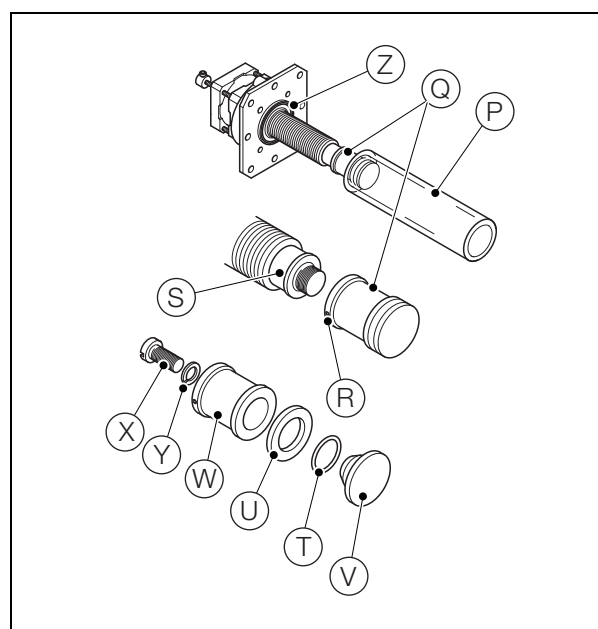

Fig. 13.15 Dismantling/Reassembling the Piston

9. Referring to Fig. 13.14, refit the motor and sample tube (O) to the lower half of the measurement cell, ensuring that the motor wiring plug is aligned with the socket (see (M) in Fig. 13.13). Secure the motor mounting plate to the lower half of the measurement cell with the four screws (N).
10. Referring to Fig. 13.13, reconnect the motor wiring plug (M).
11. Referring to Fig. 13.12, refit the measurement cell top cover (L) and secure with the two screws (K).
12. Referring to Fig. 13.11,
 - a. Fit a new O-ring (I) to end cap (H), ensuring it is located correctly in the groove in the end cap.
 - b. Invert the measurement cell assembly and position end cap (H) over the end of the sample tube (J).
 - c. Refit base plate (G) ensuring that the end cap is centered in the hole in the base plate. Secure the base plate with the four screws (F).
13. Referring to Fig. 13.10, refit cover (E).
14. Referring to Fig. 13.9:
 - a. Locate the measurement cell assembly onto the analytical section back plate and secure with the four M4 screws (C).
 - b. Reconnect measurement cell ribbon cable (B).

13.3.7 Completion

1. Referring to Fig. 13.8, raise the analytical section to the upright position and secure with handle (A).
2. Referring to Fig. 13.6, connect the new interconnect tube to the connector (C) at the base of the measurement cell assembly.
3. Turn on the sample feed to the side sample pot.
4. Restore the power supply to the analyzer and select **Prime & Calibrate** from the operator menu – see Section 9.4, page 51.

14 Specification

Measurement Range

Aluminium

Auto-ranging	0 to 1.500 ppm Al
Undiluted range	0 to 0.300 ppm Al
Diluted range	0.3 to 1.500 ppm Al

Ammonia

Auto-ranging	0 to 3.000 ppm NH ₃
Undiluted range	0 to 0.500 ppm NH ₃
Diluted range	0.5 to 3.000 ppm NH ₃

Color

Range	0.00 to 500 Hazen units 0.00 to 500 mg/l Pt-Co
-------	---

Iron

Auto-ranging	0 to 5.000 ppm Fe
Undiluted range	0 to 1.000 ppm Fe
Diluted range	1 to 5.000 ppm Fe

Manganese

Auto-ranging	0.02 to 10 ppm Mn
Undiluted range	0.02 to 2 ppm Mn
Diluted range	2 to 10 ppm Mn

Manganese low range

Range	0.000 to 0.100 ppm Mn
-------	-----------------------

Phosphate

Auto-ranging	0.05 to 50 ppm PO ₄
Undiluted range	0.05 to 10 ppm PO ₄
Diluted range	10 to 50 ppm PO ₄

Chemical Method

Aluminium

Pyrocatechol Violet (PCV)

Ammonia

Indophenol blue

Color

Measurement of water color by absorbance at 400nm expressed in Alpha-Hazen scale or Platinum-Cobalt scale

Iron

Tripyridyl-triazine (TPTZ)

Manganese

Formaloxime

Manganese low range

Malachite green

Phosphate

Phosphomolybdenum blue

Background color correction (not applicable to Aztec 600 Color)

Compensated at the measurement wavelength

Self-cleaning

Programmable automatic chemical rinsing – piston mechanically cleaned every measurement

Measurement Mode

Batch measurement

User-selectable measurements per hour:

Aluminium/iron/manganese: 1 to 6

Ammonia/phosphate: 1 to 4

Color: 1 to 12

Sample streams

Single or up to 3 streams – sequencing is programmable

Measurement Performance

Accuracy¹

Al/Am/Fe/PO ₄	<±5 % of reading ² or ±0.005 ppm (whichever is the greater)
Color	0 to 300 Hazen <±2 % of reading ² or ±0.5 Hazen (whichever is the greater) 300 to 500 Hazen <±5 % of reading ²
Mn	<±5 % of reading ² or ±0.005 ppm for 0 to 5 ppm Mn (whichever is the greater) <±7 % of reading ² or ±0.005 ppm for 5 to 10 ppm Mn (whichever is the greater)
Mn (low range)	<±0.005 ppm for 0.000 to 0.050 ppm ² <±0.010 ppm for 0.050 to 0.100 ppm ²

Repeatability

Al/Am/Fe/Mn	<±5 % of reading ³ or ±0.005 ppm (whichever is the greater)
Color	<±1 % of reading ³ (at 20% of span)
Mn (low range)	<±5 % of reading ³ or ±0.001 ppm (whichever is the greater)
PO ₄	<±5 % of reading or ±0.030 ppm (whichever is the greater)

Resolution

Al/Am/Fe/Mn/PO ₄	0.001 ppm or 1 ppb
Color	<±3 % of reading ² or ±0.5 Hazen for 0 to 200 Hazen (whichever is the greater) <±5 % of reading ² for 200 to 300 Hazen <±8 % of reading ² for 300 to 500 Hazen

Measurement units

Al/Am/Fe/Mn/PO ₄	mg/l, ppm, ppb, µg/l
Color	Hazen units, Pt-Co units

Calibration

2-point, automatic calibration, with the option of manual initiation. The interval between automatic calibrations is selectable manually from four times a day to once per week.

Zero Compensation Frequency (Color analyzer only)

User-selectable 1 to 12 hour frequency

¹ Maximum measured error across full measurement range.

² Tested in accordance with IEC 61298 Parts 1-4 : Edition 2.0 2008-10.

³ Tested in accordance with BS ISO 15839 : 2003.

Environmental Data

Ambient Operating Temperature

Aluminium/ammonia/iron/manganese/phosphate:
5 to 45 °C (41 to 113 °F)
Manganese low range:
5 to 35 °C (41 to 93 °F)
Color:
5 to 40 °C (41 to 104 °F)

Ambient Operating Humidity

Up to 95 % RH non-condensing

Sample Temperature

Aluminium/ammonia/color/iron/manganese/phosphate:
1 °C to 40 °C (33 to 104 °F)
Manganese low range:
1 to 35 °C (33 to 93 °F)

Sample Flow

Continuous, 200 to 500 ml/min

Sample Pressure

5 psi maximum

Sample Limitations

Samples containing particles 100 microns (0.004 in) in diameter and larger may require pre-filtration.

Maintenance

Routine service interval

12 months
(Manganese only – increased piston wear may occur when measuring hard water due to precipitation of calcium and manganese hydroxides)

Reagent consumption (not applicable to Aztec 600 Color)

0.75 ml of each reagent per measurement

Display

Color, TFT, liquid crystal display (LCD) with built-in backlight and brightness adjustment

Diagonal display area 145 mm (5.7 in)

76800 pixel display*

* A small percentage of the display pixels may be either constantly active or inactive. Max. percentage of inoperative pixels <0.01 %.

Dedicated operator keys

- Group Select/Left cursor
- View Select/Right cursor
- Menu key
- Up/Increment key
- Down/Decrement key
- Enter key

Mechanical Data**Ingress protection**

IP31*

Sample connections

Inlet: 6 mm OD push-fit x 1/4 in BSP elbow
 Outlet: 10 mm OD push-fit x 3/8 in BSP elbow

Dimensions

Height 653 mm (25.7 in)
 Width 366 mm (14.4 in) max.
 Depth 183 mm (7.2 in) door closed
 430 mm (16.9 in) door open
 Weight 15 kg (33 lb)

Materials of construction

Electronics enclosure 10 % glass loaded polycarbonate
 Main enclosure Noryl
 Lower tray 20 % glass loaded polypropylene
 Door Acrylic

Electrical**Supply ranges**

100 to 240 V max. AC 50/60 Hz \pm 10 % (90 to 264 V AC, 45/65 Hz)
 18 to 36 V DC (optional)

Power consumption

75 W max. – AC
 100 W max. – DC

Analog Outputs**Single and multi-stream analyzers**

6 isolated current outputs, fully assignable and programmable over a 0 to 20 mA range (up to 22 mA if required)

Alarms/Relay Outputs**Single- and multi-stream analyzers**

One per unit:

- Stop relay
- Attention relay
- Failure relay
- Calibrate relay

Six per unit:

- Fully user-assignable alarm relays

Rating

Voltage	250 V AC	30 V DC
Current	5 A AC	5 A DC
Loading (non-inductive)	1250 VA	150 W

*Not evaluated for UL or CB

Connectivity/Communications**Ethernet connection**

Web server with ftp For real-time monitoring, configuration, data file access and e-mail capability

Bus communications

Profibus DP V1.0 (optional)

Data Handling, Storage and Display**Security**

Multi level security Operator and configuration
 Password or security switch

Storage

Removable Secure Digital (SD) card

Trend analysis

Local and remote

Data transfer

SD card or FTP

Approvals, Certification and Safety**Safety Approval**

cULus

CE Mark

Covers EMC & LV Directives (including latest version EN 61010)

General Safety

EN 61010-1

Overvoltage Class 11 on inputs and outputs

Pollution category 2

EMC**Emissions & immunity**

Meets requirements of IEC61326 for an Industrial Environment

DS/AZT6AL-EN Rev. F
 DS/AZT6AM-EN Rev. C
 DS/AZT6C-EN Rev. B
 DS/AZT6IR-EN Rev. H
 DS/AZT6ML-EN Rev. C
 DS/AZT6MN-EN Rev. D
 DS/AZT6P-EN Rev. D

Appendix A – Reagents

A.1 Reagent Solutions



Warning.

- Ensure personal protective equipment (PPE) such as **gloves** and **eye protection** are worn during any maintenance and that any spillages are cleaned-up.
- Observe all health and safety procedures for handling chemicals.

A standard set of reagents for an Aztec 600 analyzer (except an Aztec 600 color analyzer) comprises 3 reagents (5 l of each) and a high calibration standard (2.5 l). The Aztec 600 color analyzer does not use reagents for measurement; a high calibration standard is used only for automatic calibration.

Because the usage of de-ionised water depends on the measurement range (see Table A.1) this is supplied separately and available in 10 or 25 l sizes.

Aztec 600 Analyzer	Reagent 1 (5 l)	Reagent 2 (5 l)	Reagent 3 (5 l)	Standard (2.5 l)
Aluminium	Acid	Buffer	Color	0.2 ppm Al
Ammonia	Color	Catalyst	Alkaline Reagent	0.35 ppm NH ₃ (0.288 ppm NH ₃ -N)
Color	N/A	N/A	N/A	50 Hazen (50 mg/l Pt-Co)
Iron	Acid	Buffer	Color	0.2 ppm Fe
Manganese	Buffer	Color	Complexing Agent	0.5 ppm Mn
Manganese Low Range	Preconditioner	Buffer/Oxidizing Agent	Color	0.1 ppm Mn
Phosphate	Acid Molybdate Reagent	Reducing Agent	N/A	1 ppm PO ₄ -P (3.066 ppm PO ₄)

Table A.1 Reagent Sets/Standard Measurement Range

The default calibration standards are selected to give accurate results across the most frequently used measurement ranges.

A.1.1 Reagent Storage

Store reagents in their original packaging, in a cool, dry, well ventilated environment.

Note.

- Do not use reagents outside their shelf life.
- The following reagents are sensitive to light and must be stored in dark bottles:
 - Ammonia – Reagents 2 and 3
 - Low Range Manganese – Reagent 3

Contact with visible, ultraviolet or infrared radiation shortens the shelf life of these reagents.

2 types of reagent bottle kit are available from ABB – see Appendix F.3, page 96.

A.2 Reagent Consumption

The reagent usage depends on how many samples an hour are measured.

Typically 0.75 ml of each reagent is used per determination.

Samples Measured Per Hour	Duration of Reagent Set (Days)
1	240
2	120
3	80
4	60
5	50
6	40

Table A.2 Reagent Consumption

A.3 Consumption of Sample, Standards and Dilution Water

The usage of sample and dilution water depends on the range the analyzer is measuring and the number of sample rinses selected.

Refer to Tables A.3 and A.4 to determine the sample and dilution water usage per measurement. For High Level Manganese, only 4 to 6 rinses should be allowed, for all other parameters, only 0 to 4 rinses should be allowed.

The default cell rinse is 4 for high level manganese and 2 for all others.

Dilution Ratio	No. of Cell Rinses			
	0	1	2	3
1:0	7.5 ml Sample 0 ml DI Water	17 ml Sample 0 ml DI Water	26.5 ml Sample 0 ml DI Water	36 ml Sample 0 ml DI Water
1:1	3.75 ml Sample 3.75 ml DI Water	8.5 ml Sample 8.5 ml DI Water	13.25 ml Sample 13.25 ml DI Water	18 ml Sample 18 ml DI Water
1:2	2.5 ml Sample 5.0 ml DI Water	5.7 ml Sample 11.3 ml DI Water	8.85 ml Sample 17.65 ml DI Water	12 ml Sample 24 ml DI Water
1:3	1.90 ml Sample 5.60 ml DI Water	4.25 ml Sample 12.75 ml DI Water	6.6 ml Sample 19.9 ml DI Water	9 ml Sample 27 ml DI Water
1:4	1.5 ml Sample 6.0 ml DI Water	3.4 ml Sample 13.6 ml DI Water	5.3 ml Sample 21.2 ml DI Water	7.2 ml Sample 28.8 ml DI Water

Table A.3 Sample and DI Usage per Measurement – 0 to 3 Rinses

Dilution Ratio	No. of Cell Rinses		
	4	5	6
1:0	45.5 ml Sample 0 ml DI Water	55 ml Sample 0 ml DI Water	64.5 ml Sample 0 ml DI Water
1:1	22.8 ml Sample 22.8 ml DI Water	27.5 ml Sample 27.5 ml DI Water	32.3 ml Sample 32.3 ml DI Water
1:2	15.2 ml Sample 30.3 ml DI Water	18.3 ml Sample 36.7 ml DI Water	21.5 ml Sample 43.0 ml DI Water
1:3	11.4 ml Sample 34.1 ml DI Water	13.8 ml Sample 41.3 ml DI Water	16.1 ml Sample 48.4 ml DI Water
1:4	9.1 ml Sample 36.4 ml DI Water	11.0 ml Sample 44.0 ml DI Water	12.9 ml Sample 51.6 ml DI Water

Table A.4 Sample and DI Usage per Measurement – 4 to 6 Rinses

Refer to Table A.5 to determine the amount of de-ionised water and standard used per calibration.

Number of Cell Rinses	DI Water Usage	Calibration Standard Usage
0	7.5 ml	7.5 ml
1	17 ml	17 ml
2	26.5 ml	26.5 ml
3	36 ml	36 ml
4	45.5 ml	45.5 ml
5	55.0 ml	55.0 ml
6	64.5 ml	64.5 ml

Table A.5 Calibration Solution Usage

A.4 Cleaning Solutions

If a chemical cleaning cycle is run on the analyzer, the routine uses approximately 8 ml of cleaning solution per cleaning cycle.

Appendix B – Troubleshooting

B.1 Analyzer Malfunction

In the majority of cases any problems experienced are usually associated with the chemistry and the liquid handling section.

Check mechanical components that are involved with the liquid handling systematically. For example, check pumps, valves, tubing and tubing connections for correct operation and for leaks or blockages that change the chemical conditions within the analyzer.

Caution. Check that there have been no unauthorized modifications, for example, incorrect tubing fitted.

A calibration fail can be caused by almost any part of the liquid handling section of the analyzer, including the solutions.

Measurement variations may be due to air bubbles within the sample entering the measurement cell or particulates causing restrictions within the analyzer sample tubing and valve block.

Any unpredictable problems may be due to the standard or reagent solutions or their flow through the analyzer. If any doubts exist regarding the integrity of these solutions, replace with new solutions in the early stages of the fault finding investigations. Ensure reagent solutions are connected correctly and are within their expiry date.

B.2 Cell Diagnostics

Within the Cell Diagnostics (see Section 10.2, page 54), operation of the analyzer can be controlled manually.

This mode is used to check the basic performance of the analyzer, such as the operation of the piston assembly, the activation of valves and the general fluid handling.

It also displays the detector output in real time, allowing the checking of the LED light source and the response of the detector.

B.3 Effects of Loss of Power to the Analyzer

The automatic action taken by the analyzer following loss of power is dependent upon the length of time the power was off.

Table B.1 shows the automatic functions performed:

Analyzer Status	Period of Loss of Power	
	< 6 hours	> 6 hours
During measurement, calibration or cleaning	Function: 1. Piston resets 2. Analyzer performs a prime routine 3. Analyzer performs a calibration 4. Analyzer goes into measurement Analyzer analog outputs are held at the last output levels prior to the loss of power. Analyzer relay outputs are re-evaluated after power restoration on the basis of current operating conditions. The measurement display retains the last value recorded before loss of power.	Function: 1. Piston resets 2. Analyzer performs a prime routine 3. Analyzer performs a calibration 4. Analyzer goes into measurement Analyzer analog outputs are reset to minimum. Analyzer relay outputs are re-evaluated after power restoration on the basis of current operating conditions. The measurement display resets (is blank) until a new measurement is completed.

Table B.1 Automatic Functions by Status/Power Loss

B.4 Simple Checks

B.4.1 Unstable or Erratic Readings

There are a number of possible causes of unstable or erratic readings. Follow the checks outlined below to determine cause. If these actions do not resolve the issue, run the analyzer on a solution of known concentration to establish if the analyzer is unstable.

Check	Action
Check operating range of analyzer	<p>The analyzer may appear to be giving erratic results, when actually the error is due to the scaling of the chart or the units being displayed.</p> <ol style="list-style-type: none"> 1. Check the analyzer is measuring within its range – see Section 14, page 74. 2. Check if the measuring range is at a similar level to the dilution set point – change the dilution amount if required – see Appendix A.3, page 78. 3. Check which units the analyzer is using to display the results.
Visual check for air bubbles	<p>Check for air bubbles in the analyzer tubing. This can indicate a loose barbed connector, incorrectly attached tubing or a faulty valve.</p> <ol style="list-style-type: none"> 1. From the sample line(s): <ol style="list-style-type: none"> a. Check the sample barbed connector on the valve manifold – tighten if necessary. b. Ensure that sample tubing is fitted correctly to the barbed connectors. c. Check the sample solenoid valve(s) and ensure that the valve face gasket is located correctly – see Section 13.3.4, page 64. 2. From the reagent line(s): <ol style="list-style-type: none"> a. Check the reagent barbed connector on the valve manifold – tighten if necessary. b. Check the reagent barbed connector on the top of the level sensor – tighten if necessary. c. Ensure that reagent tubing is fitted correctly to the barbed connectors. d. Check the reagent solenoid valve(s) and ensure that the valve face gasket is located correctly – see Section 13.3.4, page 64. 3. Drop back on all reagent lines: <ol style="list-style-type: none"> a. Check the barbed connector in the centre of the valve manifold – tighten if necessary. b. Check the barbed connector located at the base of the head assembly – tighten if necessary. c. Ensure that the tubing connecting the valve manifold to the head assembly is fitted correctly to the barbed connectors. d. Check that the piston seal is not leaking. Replace if necessary – see Section 13.3.6, page 70.
Check for restrictions in analyzer tubing	<p>Sharp bends or kinks in the tubing or compressed tubing result in restricted flow that can cause erratic or incorrect readings. Trace each of the reagent/sample lines from the valve manifold and ensure that the liquid flow is not restricted.</p> <p>Check for:</p> <ol style="list-style-type: none"> 1. Cable ties that have been tightened around the tubing – remove if necessary. 2. Check that tubing is not trapped or squashed. 3. Check that there are no kinks in the tubing – replace tubing. 4. Check integral filter located at the base of the reagent level sensor has not become blocked. 5. Ensure analyzer waste is free-flowing to an open drain (not submerged).

Check	Action
Check valves/valve manifold for blockages	<p>Blockages in the valves or the valve manifold result in incorrect dosage of reagent or sample that cause erratic or incorrect readings. Check reagent usage. Excessive or reduced usage of one reagent can indicate a blocked or partially restricted valve.</p> <ol style="list-style-type: none"> 1. Disconnect the tubing from the valve block assembly. 2. Remove the valve block assembly from the analyzer. 3. Starting with the waste valve, remove the valve and check the diaphragm for particulate build-up – clean or replace if necessary. 4. With the valve removed check that there are no blockages in the valve manifold: <ol style="list-style-type: none"> a. Attach a syringe filled with de-ionised water, with a length of tubing, to the centre barb on the valve manifold. b. Depress the syringe plunger and ensure that the deionised water flows freely. c. Remove the syringe from the centre barbed connector and attach to the outer barbed connector of the valve position being tested. Depress the syringe plunger and ensure that the deionised water flows freely. d. Replace the valve, ensuring that the face gasket is located correctly. e. Repeat for each of the remaining valves. 5. Prior to refitting the valve block to the analyzer, test for an air-tight seal by attaching the syringe to the centre barbed connector, drawing back the plunger and releasing it. Check the syringe plunger returns to the start position. 6. Replace the valve block, connect the tubing and prime/calibrate the analyzer.
External Influences	<p>There are a number of external influences that cause erratic or unstable results, such as inconsistent dosage of chemicals within the process, dirty sample lines leading to the analyzer or changes in water quality.</p> <ol style="list-style-type: none"> 1. Check sample line(s) feeding the analyzer have sufficient flow to ensure that there is no settling of particles – adjust the flow and backwash the sample line(s) if necessary. 2. Check the side sample pot is clean and that no particles have built up – clean the side sample pot if necessary. 3. Check that particles outside the specification of the analyzer are not entering the side sample pot, such as coagulant breakthrough – install a pre-filter or settling pot if necessary. 4. If a pre-filter or settling pot is used, check that this is functioning correctly – clean if necessary. 5. Check the historical log of the analyzer and compare period of erratic readings against conditions.

B.4.2 High/Low Measured Values



Check/Symptom	Action
Check analyzer settings	Ensure that the analyzer is set up and operating within its specification. <ol style="list-style-type: none"> 1. Check the units the analyzer is displaying are the same as the comparison method. 2. Check the analyzer is operating within its measuring range. 3. Check the analyzer is operating within its ambient operating temperature and humidity. 4. Check that the analyzer is not operating erratically.
Check analyzer calibration	Ensure the analyzer is calibrating correctly: <ol style="list-style-type: none"> 1. Check the standard concentration matches the analyzer setting. 2. Check the optical density of the low calibration solution is within the expected range – recalibrate if necessary. 3. Check the optical density of the high calibration solution is within the expected range – recalibrate if necessary.
Check sample points and external method	When comparing analyzer results to laboratory or portable analysis techniques it is important to ensure that the samples analyzed are the same and that the analysis methods are comparable. <ol style="list-style-type: none"> 1. Check that the sample taken for external analysis is the same sample the analyzer is measuring by collecting the sample from the overflow from the side sample pot. 2. Check that samples taken are analyzed in a timely manner. 3. Check that the collected sample does not undergo additional treatment prior to analysis, such as further filtering, settling and acid digestion. 4. Check that the comparative analysis method is not measuring the 'Total' amount of the parameter in the sample. For example, laboratory methods such as ICP analysis may read higher than online analysis methods on raw waters. 5. If a portable test kit or bench-top instrument is used for comparison, ensure that this is measuring accurately. Check: <ol style="list-style-type: none"> a. reagents used are in date b. the instrument has been calibrated c. performance on known standards d. the analyzer is operating within its working range and accuracy
Check filter	If a filter is used prior to the analyzer, it is possible that some important parameters are being filtering out before analysis takes place: <ol style="list-style-type: none"> 1. Analyze a sample taken before and after the filter to check if the concentration changes significantly.

B.4.3 Excessive Usage of Reagent(s)

Check/Symptom	Procedure and Action
Check analyzer measurement and calibration settings	<p>The frequency of measurement and calibration of the analyzer is adjustable.</p> <p>The default frequency for most Aztec 600 analyzers is 6 measurements per hour with a calibration every 24 hours.</p> <p>This can be reduced to save reagent and standard usage:</p> <ol style="list-style-type: none">1. Press the  key and enter the configuration menu to configure the analyzer.2. Set the Measurement Frequency – see Section 6.2.1, page 32.3. Set the Calibration Time and Frequency – see Section 6.3.1, page 33.
Excessive usage of one reagent	<p>Excessive usage of one reagent could indicate a blocked or partially-restricted flow through the analyzer or air entering through a barbed connector:</p> <ol style="list-style-type: none">1. Check for restrictions in analyzer tubing – see Appendix B.4.1, page 80.1. Check valves/valve manifold for blockages – see Appendix B.4.1, page 80.1. Check for signs of air bubbles – see Appendix B.4.1, page 80.

B.4.4 Calibration Failure

A calibration failure could be caused by almost any part of the liquid handling section of the analyzer, including the solutions.

Check/Symptom	Action
Calibration failure after fitting a new set of reagents on the analyzer	<p>If the calibration failed after fitting a new set of reagents on the analyzer, it is possible that these have been fitted incorrectly, a piece of tubing has become restricted during the process or the reagent lines were not fully primed.</p> <ol style="list-style-type: none"> 1. Check that the reagents are the correct type, connected correctly (reagent 1 to valve R1 etc.) and within their shelf life. 2. Check that the calibration settings are correct and have not been modified. <ol style="list-style-type: none"> 1. Check the analyzer tubing for restrictions, blockages or leaks – see Appendix B.4.1, page 80. 2. Check that the reagents have been fully primed, perform a Prime Lines and Calibrate routine.
Failure of a routine calibration	<p>The most likely causes of a routine calibration failure are; a valve becoming blocked, a leaking piston seal or the reagents or standards becoming contaminated.</p> <p>View the failed calibration results and check against expected values:</p> <ol style="list-style-type: none"> 1. Enter the Calibration Status screen of the analyzer – Press the  key and scroll up to Diagnostics, press the  key and enter Monitor Status. Press the  key to enter Cal. 2. Check the OD Low value and the OD High value against the acceptable values – see Table C.3, page 89 for acceptable values. <p>OD Low Value too High</p> <p>If the OD Low value is too high, too much color is being formed when measuring the blank. This could be due to the de-ionised water becoming contaminated, a restriction in the tubing or a faulty valve.</p> <ol style="list-style-type: none"> 1. Replace the DI water with fresh solution and prime and calibrate the analyzer. 1. Check the analyzer tubing and valves for restrictions, blockages or leaks – see Appendix B.4.1, page 80. <p>OD High Value too Low</p> <p>If the OD High value is too low, not enough color is being formed when measuring the standard. This could be due to the standard becoming contaminated, a fault with the reagents, a restriction in the tubing, a faulty valve or a leaking piston seal.</p> <ol style="list-style-type: none"> 1. Check the analyzer tubing and valves for restrictions, blockages or leaks – see Appendix B.4.1, page 80. 2. Check that the piston seal is not leaking and the glass cell is not damaged. Replace if necessary – see Section 13.3.6, page 70. 3. Replace the reagents and standards and prime and calibrate the analyzer. <p>OD High Value too High</p> <p>If the OD High value is too high, too much color is being formed when measuring the standard. This could be due to the standard becoming contaminated, a fault with the reagents, a restriction in the tubing, a faulty valve or a leaking piston seal.</p> <ol style="list-style-type: none"> 1. Check the analyzer tubing and valves for restrictions, blockages or leaks – see Appendix B.4.1, page 80. 2. Check that the piston seal is not leaking and the glass cell is not damaged – replace if necessary – see Section 13.3.6, page 70. 3. Replace the reagents and standards and prime and calibrate the analyzer.

Appendix C – Principle of Operation

C.1 General Operation

A single piston pump is used for all hydraulic functions. This is driven by a stepper motor, ensuring precise volumes are drawn in. The piston provides the added benefit of physically wiping the optical cell when sample and reagents are introduced and expelled; resulting in an automatic cleaning process.

This cleaning process reduces maintenance and increases the accuracy and repeatability of the analyzer.

The piston pump design enables the analyzer to make use of a unique patented air mixing system. The final upward movement of the piston coincides with the opening of the air valve, drawing air vigorously through the entry point of the optical cell and so achieving full chemical mixing.

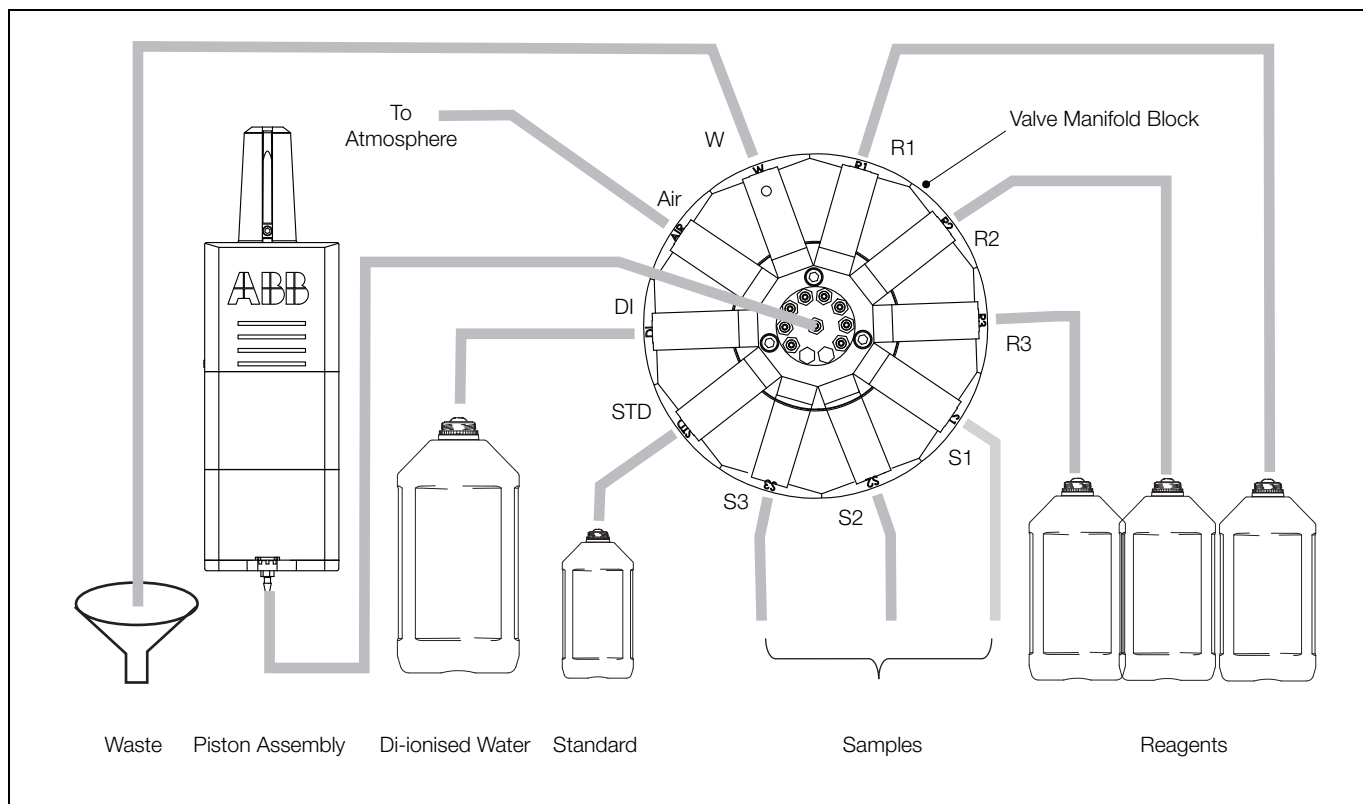

Fig. C.1 Flow Schematic

C.2 Temperature Control

The measurement head is temperature controlled. Maintaining all the optics in a temperature-controlled environment provides excellent stability and improves analyzer repeatability.

Heating the sample makes it possible to speed up certain chemical reactions, enabling a greater frequency of measurement to be achieved. It also improves the acid digestion performed with certain determinants (for example, aluminium and iron). If the environment is very cold it takes longer for the analyzer to reach operational temperature (as the analyzer is reaching temperature the message 'Stabilising' is displayed on the LCD).

The operational temperature can be viewed and changed – see Section 6.2.1, page 32. In low temperature environments it is recommended that the reagents are kept off the floor and are situated on a reagent shelf and insulated.

C.3 Measurement Cycle

The sample pot fills with sample and overflows at the top to maintain a constant head from where sample is taken to be measured. The float inside the pot contains a small magnet that operates a reed switch. When the float is in the uppermost position the switch is held closed. If the sample stops flowing the float drops slowly allowing the reed switch to open, giving a sample flow failure indication.

The piston pump collects a discrete sample of water from the side sample pot at intervals of 10 to 60 minutes (determined by the user). The transmission of light is measured to remove the actual background color and turbidity effects.

Reagents are added and mixed with the aid of the air. After allowing time for color development the light transmission is re-measured, the background value removed and the remaining light level converted into a concentration value.

The result is logged, shown on the display (as a value, or graphically) and transmitted as a current signal. If the value is under, or exceeds pre-programmed limits for the measurement stream, the appropriate alarm limit relay is activated.

C.4 Calibration Cycle

Automatic calibrations can be performed from every 6 hours to once per week. The measurement cycle is interrupted for calibration. Calibration involves repeating the measuring cycle with de-ionised water and then a known standard. The two values obtained are used to produce a calibration graph. The analyzer compares the calibration graph with the ideal working curve stored within its memory.

If the variation between the ideal working curve and the 2-point calibration is acceptable, the analyzer returns to the measurement cycle – if it is not the analyzer fails calibration.

C.5 LED Calibration

Before each calibration the analyzer checks the LED output, and if required adjusts it accordingly. This is achieved by analyzing the detector response on de-ionised water.

The detector output is scaled in counts. The full range of the scaling is 0 to 4095 counts. De-ionised water gives the maximum transmission, so the electronic scaling is set to provide a detector response with de-ionised water of 3300 detector counts (80 % of scale).

If the detector response is 3300 ± 100 detector counts, no adjustment is necessary; otherwise the LED current is adjusted automatically until the detector reads 3300 ± 25 counts.

This adjustment allows the use of different LEDs to measure different determinants, operate the analyzer at different temperatures and overcome cell fouling with no detrimental effect on performance.

C.6 Dilution Cycle

The Aztec 600 analyzers are capable of automatic dilution to increase their range.

If a sample is too concentrated, the measured value is outside the working range of the analyzer. The next time the sample is measured, the analyzer dilutes the sample to bring the value within the working range.

When in dilution mode the sample is diluted with de-ionised water. The dilution ratio can be programmed from 1:1 to 1:4 (1 part sample to 4 parts dilution water).

The ability to reduce the dilution factor can be an advantage in allowing more accurate measurement where the sample concentration is close to, but just above, the undiluted range limit. A reduced dilution factor also reduces the usage of deionised water. However, caution must be taken when reducing the dilution factor, to ensure that the working range of the analyzer is not exceeded.

The analyzer continues to measure the sample in dilution mode until the concentration is such that dilution is no longer necessary.

Analyzer	Enter Dilution Mode	Exit Dilution Mode
Aztec 600 Aluminium	0.33 ppm Al	0.27 ppm Al
Aztec 600 Ammonia	0.55 ppm NH ₃	0.45 ppm NH ₃
Aztec 600 Iron	1.1 ppm Fe	0.9 ppm Fe
Aztec 600 Manganese	2.2 ppm Mn	1.8 ppm Mn
Aztec 600 Phosphate	11.0 ppm PO ₄	9.0 ppm PO ₄

Table C.1 Analyzer Dilution Points

Note. The Aztec 600 Color and Aztec 600 Manganese Low range analyzers do not enter dilution mode.

C.7 Chemical Measurement Methods Used

Analyzer	Chemical Method	Principle of Measurement	Analyzer Sequence
Aztec 600 Aluminium	Pyrocatechol Violet	Based on measurement of the blue colored complex formed by the reaction between aluminium and pyrocatechol violet in a suitably-buffered solution. Acidification of the sample is normally sufficient treatment to convert all forms of aluminium to those that react with the pyrocatechol violet with the exception of suspended aluminates.	<ol style="list-style-type: none"> 1. Rinse cell with sample. 2. Bring in reagent 1 (acid). 3. Bring in sample. 4. Wait for 3 minutes (converts Al to a form that reacts). 5. Measure the background to correct for natural color. 6. Bring in reagent 2 (adjusts to correct pH). 7. Bring in reagent 3 (color-forming reagent). 8. Mix with air. 9. Wait for 5 minutes to allow color to develop. 10. Measure final color formed, account for background and output result as a concentration.
Aztec 600 Ammonia	Indophenol Blue	Ammonia reacts in a buffered alkaline solution in the presence of a catalyst to give monochloramine. The resulting monochloramine product then reacts with a phenolic compound, giving the indophenol blue compound which is measured spectrophotometrically in the analyzer.	<ol style="list-style-type: none"> 1. Rinse cell with sample. 2. Bring in color reagent. 3. Bring in sample. 4. Wait 30 seconds. 5. Measure background absorbance. 6. Bring in catalyst. 7. Bring in alkaline buffer. 8. Mix with air. 9. Wait 10 minutes for color to develop. 10. Measure final absorbance.
Aztec 600 Color	Absorbance	The absorbance of the sample is measured at 400nm and expressed as a color corresponding to the Platinum-Cobalt Scale (Pt-Co) or Hazen Scale.	<ol style="list-style-type: none"> 1. Rinse cell with sample. 2. Bring in sample. 3. Wait 25 seconds. 4. Measure sample absorbance.
Aztec 600 Iron	TPTZ	Based on the measurement of the blue-purple colored complex formed by the reaction between iron and tripyridyl-triazine (TPTZ) in a suitably buffered solution. Acidification of the sample is normally sufficient treatment to convert all forms of iron to those that react with the TPTZ.	<ol style="list-style-type: none"> 1. Rinse cell with sample. 2. Bring in reagent 1 (acid). 3. Bring in sample. 4. Wait for 4 minutes (converts Fe to a form that reacts). 5. Measure the background to correct for natural color. 6. Bring in reagent 2 (adjusts to correct pH). 7. Bring in reagent 3 (color-forming reagent). 8. Mix with air. 9. Wait for 3 minutes to allow color to develop. 10. Measure final color formed, account for background and output result as a concentration.

Table C.2 Chemical Measurement Methods Used

Analyzer	Chemical Method	Principle of Measurement	Analyzer Sequence
Aztec 600 Manganese	Formaloxime	Based on the red / orange complex formed between formaloxime and Manganese in a suitably buffered solution.	<ol style="list-style-type: none"> 1. Rinse cell with sample. 2. Bring in sample. 3. Measure background absorbance. 4. Bring in Buffer reagent. 5. Bring in formaloxime color reagent. 6. Wait for 2 minutes. 7. Bring in Iron complexing reagent. 8. Mix with air. 9. Wait 5 minutes for color to develop. 10. Measure final absorbance.
Aztec 600 Manganese Low Range	Malachite Green	Based on the malachite green triphenyl dye which is formed in an oxidation reaction involving manganese and leucomalachite green.	<ol style="list-style-type: none"> 1. Rinse cell with sample. 2. Bring in preconditioner to remove chlorine interference. 3. Bring in sample. 4. Wait for 30 seconds. 5. Measure background absorbance. 6. Bring in bring in buffer/oxidant. 7. Wait 5 minutes. 8. Bring in color forming reagent. 9. Mix with air. 10. Wait 3 minutes for color to develop. 11. Measure final absorbance.
Aztec 600 Phosphate	Phosphomolybdenum Blue	Based on the yellow complex formed between molybdate and phosphate. The reducing agent then modifies this complex to give the phosphomolybdenum blue color.	<ol style="list-style-type: none"> 1. Rinse with sample. 2. Bring in Acid Molybdate reagent. 3. Bring in sample. 4. Measure background absorbance. 5. Wait 1 minute 30 seconds. 6. Bring in reducing agent. 7. Mix with air. 8. Wait for 11 minutes for color to develop. 9. Measure final absorbance.

Table C.2 Chemical Measurement Methods Used (Continued)

C.8 Typical Analyzer Calibration Data

Aztec 600 Analyzer	OD Low	OD High	Calibration Gradient
Aluminium	0.035 to 0.085	0.400 to 0.600	2.000 to 2.700
Ammonia	0.010 to 0.070	0.245 to 0.420	0.630 to 1.000
Color	0.000	0.056 to 0.084	595 to 893
Iron	0.000 to 0.010	0.100 to 0.120	0.450 to 0.600
Manganese	-0.020 to 0.000	0.120 to 0.140	0.240 to 0.300
Manganese Low Range	0.000 to 0.100	0.580 to 0.750	5.500 to 7.500
Phosphate	-0.005 to 0.015	0.210 to 0.240	0.064 to 0.080

Table C.3 Typical Analyzer Calibration Data

Appendix D – Web Server

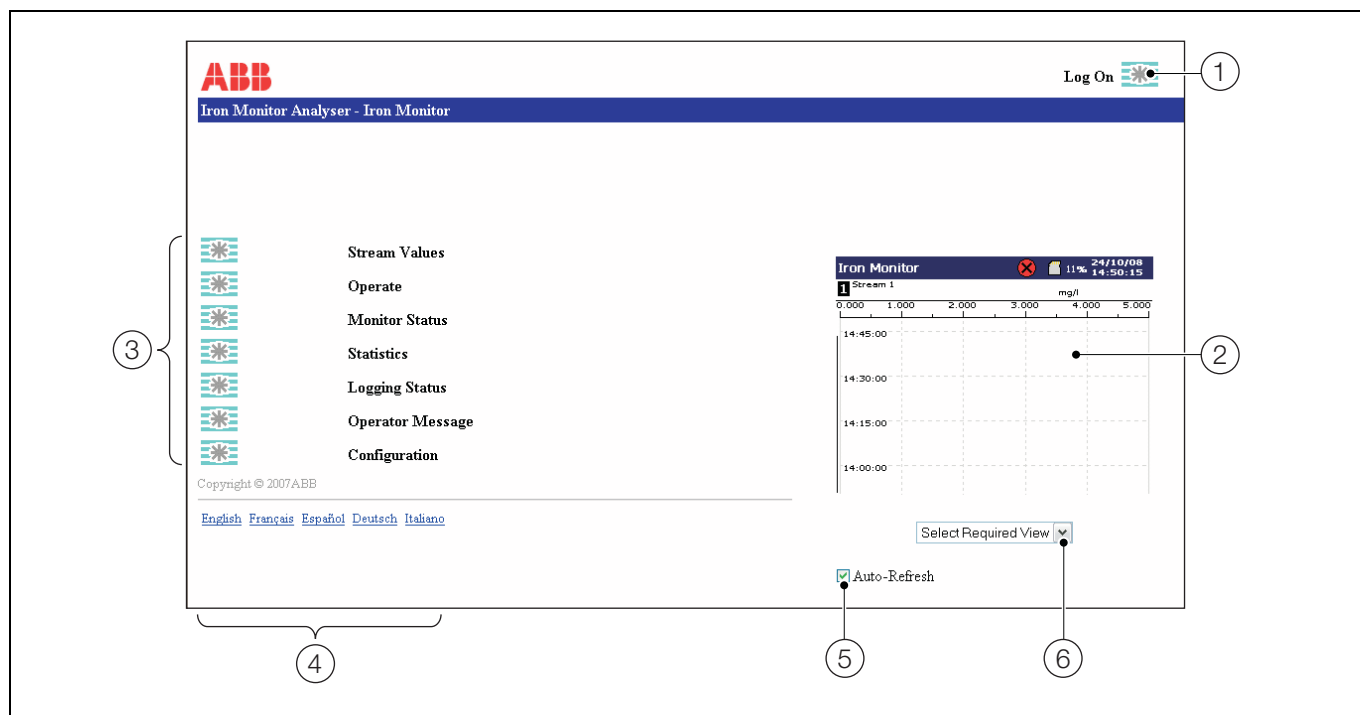

Fig. D.1 Web Server Screen

The analyzer is fitted with an ethernet card as standard and, when the appropriate configuration settings have been made, users can access the analyzer's data via an Ethernet network.

In addition, files can be transferred to and from the analyzer via an FTP connection.

- a **Log On** – click to log on to the analyzer to enable configuration access (displayed only if the analyzer is configured for FTP access – see Section 6.7.1, page 39).
- b **Analyzer View** – displays the current screen of the analyzer. If the analyzer has a screen-saver set, it does not affect this view.
- c **Access Buttons** – provides access to the analyzer's data if the user has the appropriate access permission.
 - **Stream Values** – see Appendix D.1, page 90
 - **Operate** – see Appendix D.2, page 91
 - **Monitor Status** – see Appendix D.3, page 91
 - **Statistics** – see Appendix D.4, page 91
 - **Logging Status** – see Appendix D.5, page 91
 - **Operator Message** – see Appendix D.6, page 91
 - **Configuration** – see Appendix D.7, page 92

- d **Language Selection** – selects the language for the web pages.
- e **Auto-Refresh** – updates the analyzer view automatically.
- f **View Selection** – selects the required analyzer view:
 - Alarm / Event Log
 - Audit Log
 - Chart View
 - Bar View

D.1 Stream Values

Stream	Tag	Value	Time of last measurement	Alarms	Alarm Ack
1	Stream 1	4ppm	11.00 2 Mar 2008		
2	Stream 2	4ppm	11.12 2 Mar 2008		
3	Stream 3	1ppm	11.24 2 Mar 2008		

D.2 Operate

Note. Menu options from the 'Operate' window start the routine described when the associated button is selected.

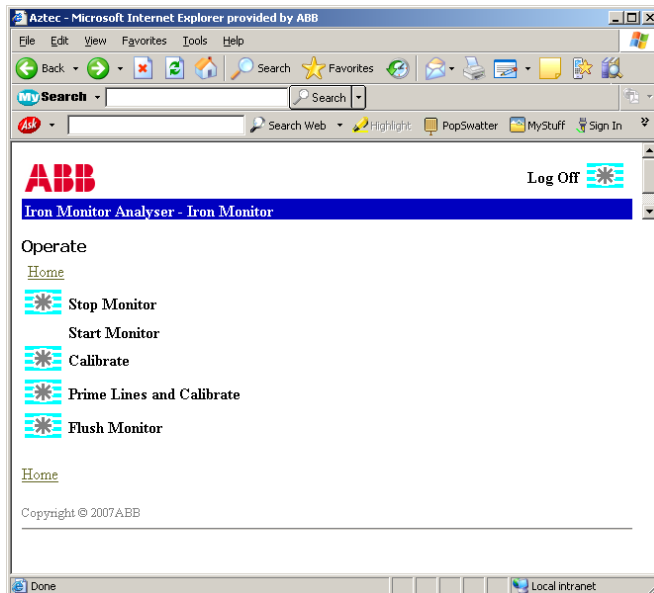

D.3 Monitor Status

Status	Calibration	I/O	Information
Current State	Operation Complete		
Current Step	N/A		
Measurement Complete	0 %		
Sample Concentration / Detector mV	N/A / 0 mV		
LED Current	4.64 mA		
Dilution Ratio	1:0 1:0 1:0		
Cell Temperature	26.6 °C		

D.4 Statistics

Stream	Tag	Minimum	Maximum	Average	Since
1	Stream 1	127.7ppb	156.3ppb	142.0ppb	10:21 2 Mar 2007
2	Stream 2	67.4ppb	74.6ppb	71.0ppb	10:21 2 Mar 2007
3	Stream 3	103.4ppb	110.6ppb	107.0ppb	10:21 2 Mar 2007

D.5 Logging Status

Description	Status
Media Status	Off-Line
Memory Used	11%
Time Remaining	< 1 Hour
Archive Status	OFF

D.6 Operator Message

ABB
Iron Monitor Analyser - Iron Monitor

Operator Message

Username

Password

Message Instruction

[Home](#)

An 'Operator Message' is displayed on the chart view. For example:

12:25:10	Checked PC
----------	------------

An entry is also included in the 'Alarm Event Log'.

An Instruction is displayed on the analyzer as a warning, for example:

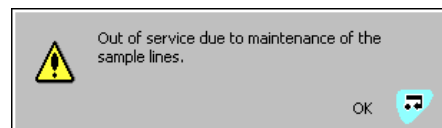

Operator instructions can be removed only by pressing the key.

To send an operator message or instruction to the analyzer:

1. Type the 'User name' and 'Password'. Up to 160 characters can be used. These are the FTP username and password that are set in the configuration – see Appendix D, page 90.
2. Type either the message or an instruction (only one field can be populated at any one time).
3. Click the button to send the message or instruction to the analyzer.

D.7 Configuration

Note. A user must be logged-on for the configuration button to be enabled.

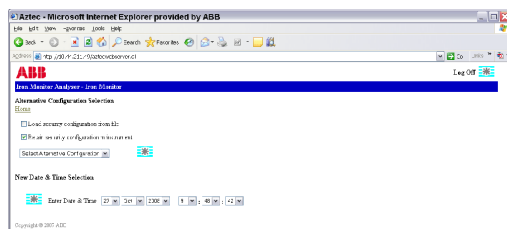

D.8 FTP Access

Files can be transferred between the analyzer and a remote computer via an FTP connection if the analyzer has been configured with the appropriate settings – see Appendix D, page 90.

Either Microsoft Internet Explorer version 5.5 (or later) or MS-DOS can be used as an FTP client.

D.9 FTP Access via Internet Explorer

Note. FTP access requires Internet Explorer version 5.5 or later.

Before data can be accessed via FTP, Internet Explorer must be configured with the appropriate options.

To ensure that the latest data file is copied, Internet Explorer must be set to check for newer versions of stored pages on every visit to a page. Internet Explorer must also be set to enable FTP access.

To configure Internet Explorer:

1. From the Internet Explorer 'Tools' menu select 'Internet Options'.
2. In the 'General' tab of the displayed dialog box, click the 'Settings' button in the 'Temporary Internet Files' grouping.
3. From the options for 'Check for newer versions of stored pages:', select 'Every visit to the page' and click 'OK'.
4. Select the 'Advanced' tab of the 'Internet Options' dialog box, ensure that the 'Enable folder view for FTP sites option' under the 'Browsing' heading is selected and click 'OK'.

To access data stored on the analyzer via Internet Explorer:

1. Start Internet Explorer.
2. In the 'Address' bar, enter 'ftp://' followed by the IP address of the analyzer from which the files are to be copied. A log-in dialog box is displayed:

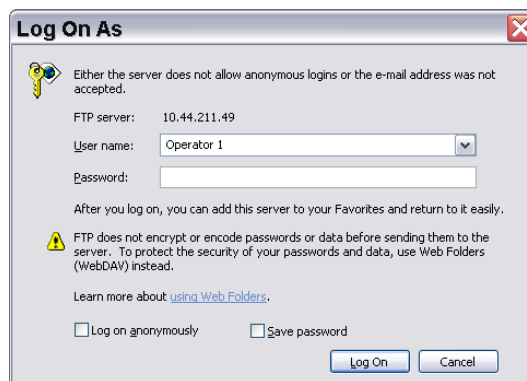

3. Type the 'User name' and 'Password' and press enter. The folders that are present on the analyzer are displayed.
4. Open the folder containing the file to be displayed. The files within the folder can be displayed in any standard Explorer view (small icon, large icon, list or details) by selecting the appropriate option from the 'Views' menu.

Note. The SDMMC folder is visible only if an SD card is present and logging is set to 'On-line' – see Section 9, page 51.

5. Files/Folders can be copied to/from the analyzer.

Note. An audit log entry is created and displayed for each FTP logon giving details of the logon user name and access (full or read-only). When Internet Explorer is used as the FTP client, two log-ons are performed at the start of each session, resulting in two log entries.

D.10 FTP Access via DataManager

DataManager can be used with FTP to access data files that have been saved to the archive media (SD card) inserted in the analyzer. For DataManager configuration details for FTP access, refer to the DataManager User Guide (IM/DATMGR).

D.11 File Transfer Program

A File Transfer Scheduler Program (FTSP) is available that enables archive and configuration files to be transferred automatically to a PC using FTP. The transferred files can be stored either on the local drive of the PC or on a network drive for easy access and secure back-up.

To download the FTSP program (FTS.exe), enter the following (without spaces) in your web browser's Address bar:

<http://search.abb.com/library/ABBLibrary.asp?DocumentID=FTS.exe&LanguageCode=en&DocumentPartId=&Action=Launch>

To download the FTSP User Guide (IM/SMFTS), enter the following (without spaces) in a web browser's address bar:

<http://search.abb.com/library/ABBLibrary.asp?DocumentID=IM/SMFTS&LanguageCode=en&DocumentPartId=&Action=Launch>

Appendix E – Updating the Software

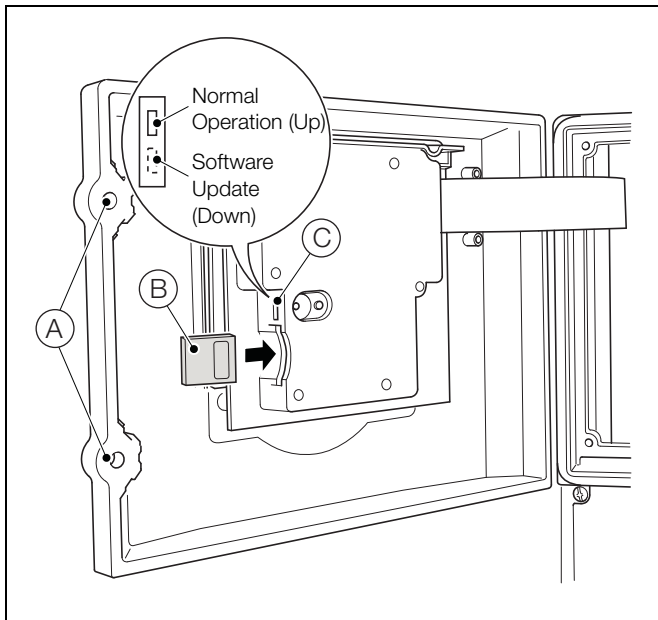

Fig. E.1 SD Card Removal

1. Stop analyzer operation by selecting 'Operate/Stop' from the main operator menu.
2. Ensure the analyzer is switched off.
3. Use a large flat-headed screwdriver to release the two door catches (A).
4. Remove the SD card (B).
5. Refer to the documentation on the web site (<http://www.abb.com>) for details of any software updates.
6. Download the software and transfer it to a blank SD card using an appropriate card reader.
7. Set the switch (C) (above the SD card socket) to the lower position (Software Update).
8. Insert the SD card, close the door and switch on the analyzer. A start-up message appears for a short duration (approximately 5 seconds) followed by a 'File Load Progress' bar then the 'ABB' splash screen:

VRD iMX21 Bootloadtr V1.2



9. A 'Warning' screen appears next. This provides the option to upgrade the existing system software or exit without upgrading:

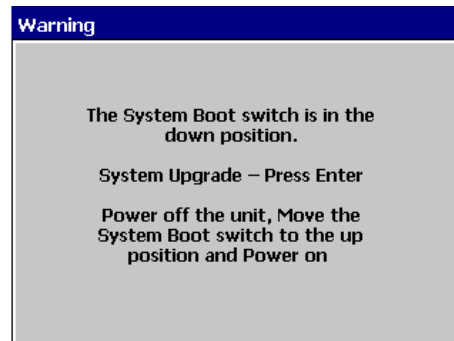

10. To proceed, press the **↵** key.
11. The 'Commissioning V2.0' screen appears with the 'Upgrade Firmware' button selected:

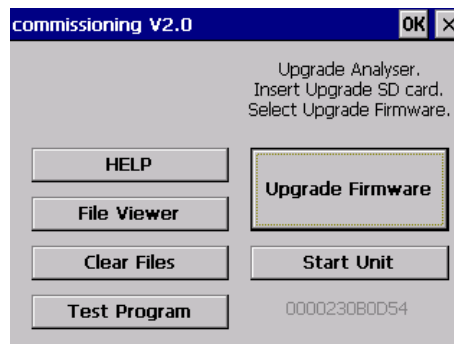



12. To upgrade the existing system software, press the **↵** key to start the process. The software is transferred to the analyzer in sections.
13. Press the **↵** key as each section is installed (installation may take a few minutes).
14. Open the door and move the switch to the up position.
15. Close the door and re-tighten the door catches (A) in Fig. E.1).
16. Turn power off and then on to restart the analyzer.

Appendix F – Spare Parts

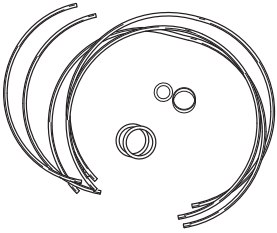
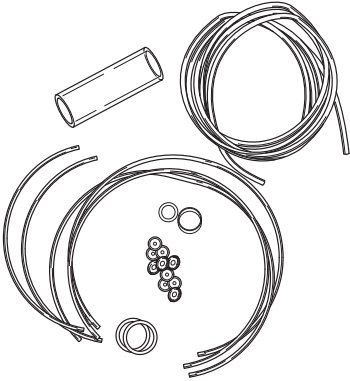
F.1 Maintenance Kits

Part No.	Description
AW630 070	Aztec 600 Colorimetric 12-monthly maintenance kit 
AW630 072	Aztec 600 Colorimetric 24-monthly maintenance kit 

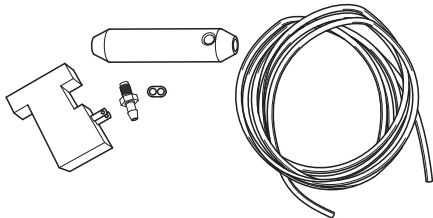
F.2 Upgrade Kits

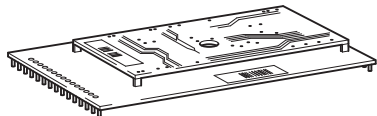
Part No.	Description
AW630 083 	Wash upgrade kit – allows a cleaning solution to be used on a single-stream analyzer 
AW600 067 	Aztec/Navigator Profibus PCB assembly 

F.3 Reagents and Reagent Bottles



Part No.	Description
AWRS630/0003	De-Ionised water (10 l) used for calibration and dilution
AWRS630/0120	Acidified de-ionised water (10 l) used for calibration of color analyzer only
AWRK631/0720	Set of Aztec Aluminium Reagents, consisting of: <ul style="list-style-type: none"> ■ Aztec Aluminium Reagent 1 (5 l) ■ Aztec Aluminium Reagent 2 (5 l) ■ Aztec Aluminium Reagent 3 (5 l) ■ Aztec Aluminium Standard (2.5 l)
AWRK632/0360	Set of Aztec Ammonia Reagents, consisting of: <ul style="list-style-type: none"> ■ Aztec Ammonia Reagent 1 (5 l) ■ Aztec Ammonia Reagent 2 (5 l) ■ Aztec Ammonia Reagent 3 (5 l) ■ Aztec Ammonia Standard (2.5 l)
AWRS630/0105	Aztec Color Standard [50 Hazen (50 mg/l Pt-Co)] (5 l)
AWRK633/0619	Set of Aztec Iron Reagents, consisting of: <ul style="list-style-type: none"> ■ Aztec Iron Reagent 1 (5 l) ■ Aztec Iron Reagent 2 (5 l) ■ Aztec Iron Reagent 3 (5 l) ■ Aztec Iron Standard (2.5 l)
AWRK635/0816	Set of Aztec Manganese Reagents, consisting of: <ul style="list-style-type: none"> ■ Aztec Manganese Reagent 1 (5 l) ■ Aztec Manganese Reagent 2 (5 l) ■ Aztec Manganese Reagent 3 (5 l) ■ Aztec Manganese Standard (2.5 l)
AWRK634/0825	Set of Aztec Manganese Low Range (LR) Reagents, consisting of: <ul style="list-style-type: none"> ■ Aztec Manganese LR Reagent 1 (5 l) ■ Aztec Manganese Reagent 2 (5 l) ■ Aztec Manganese Reagent 3 (5 l) ■ Aztec Manganese Standard (2.5 l)
AWRK636/0420	Set of Aztec Phosphate Reagents, consisting of: <ul style="list-style-type: none"> ■ Aztec Phosphate Reagent 1 (5 l) ■ Aztec Phosphate Reagent 2 (5 l) ■ Aztec Phosphate Standard (2.5 l)

Part No.	Description
AW630 030	Set of 4 x 5 l empty reagent bottles (transparent) for use with: <ul style="list-style-type: none">■ AW631 Aluminium■ AW637 Color■ AW633 Iron■ AW635 Manganese (for AW634 Manganese low range version use AW630 031)■ AW636 Phosphate
AW630 031	Set of 4 x 5 l empty reagent bottles - (opaque) for use with: <ul style="list-style-type: none">■ AW632 Ammonia■ AW634 Manganese low range
AW630 032	1 x 10 l empty bottle - (transparent) for use with de-ionised water

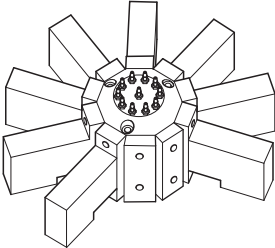
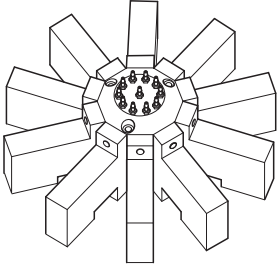
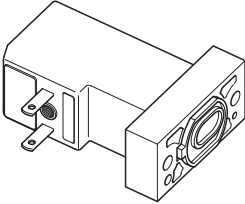
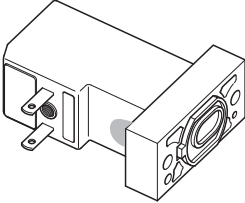

F.4 Strategic Spares

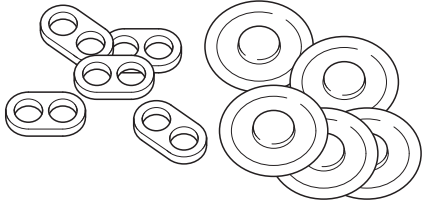
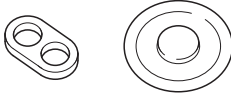
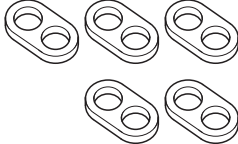
F.4.1 Valve Assemblies and Associated Parts

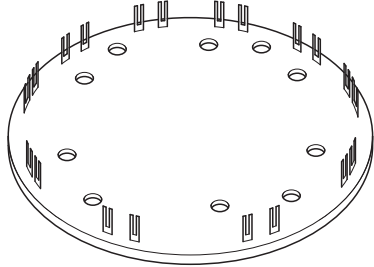
Part No.	Description
AW630 074	Replacement valve manifold assembly – single stream 
AW630 075	Replacement valve manifold assembly – multi-stream 
AW630 090	Replacement valve – EPDM diaphragm 
AW630 091	Replacement waste valve 

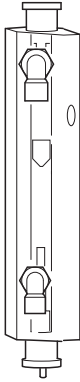
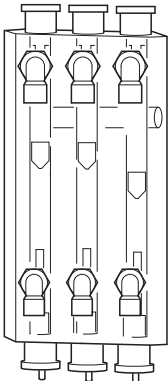
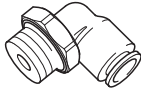

Part No.	Description
AW630 088	Pack of 5 valve diaphragms and valve face gaskets – EPDM 
AW630 089	Pack of 1 valve diaphragm and valve face gasket – for waste valve 
AW630 092	Pack of 5 valve face gaskets – EPDM 
AW630 093	Valve face gasket – for waste valve 
AW630 071	Valve PCB assembly  

F.4.2 Side Sample Pot Assemblies and Associated Parts

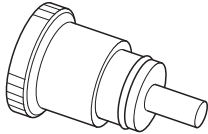
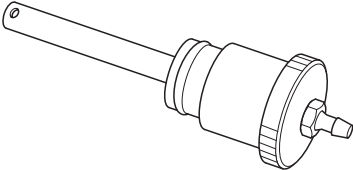
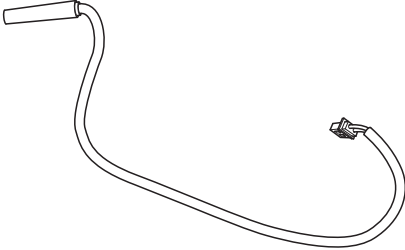
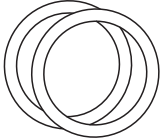

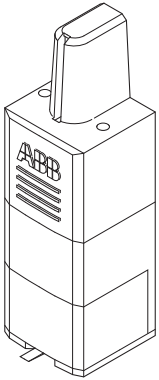
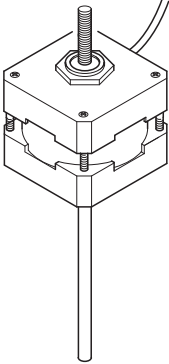
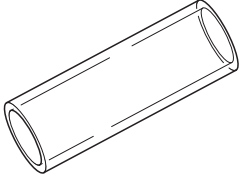

Part No.	Description
AW630 079	Complete side sample pot assembly – single-stream 
AW630 080	Complete side sample pot assembly – multi-stream 
AW630 062	Side sample pot elbow fitting – 3/8 in BSPP x 10 mm 
AW630 065	Side sample pot elbow fitting – 1/4 in BSPP x 6mm 

Part No.	Description
AW630 063	Replacement sample float assembly 
AW630 084	Sample pot top cap – complete with O-ring 
AW630 085	Sample pot bottom cap – complete with O-ring and barbed fitting 
AW630 096	Side sample pot reed switch 
AW630 067	Replacement O-rings for side sample pot, top and bottom caps 

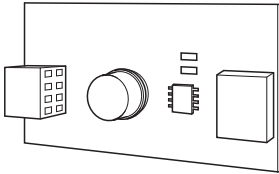
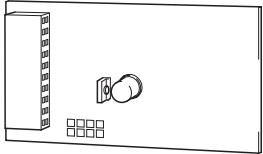
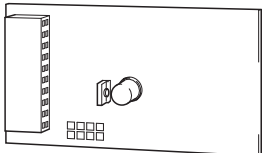
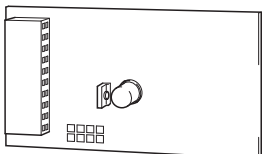

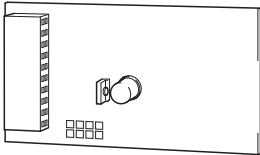
F.4.3 Measurement Head Assemblies and Associated Parts

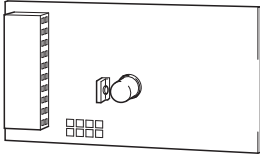
Part No.	Description
AW630 078	Measuring head assembly – without LED 
AW630 086	Measuring head linear drive stepper motor and leadscrew assembly 
AW630 097	Glass piston tube 
AW630 098	Piston seal kit 

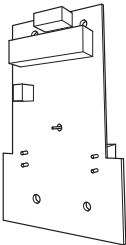
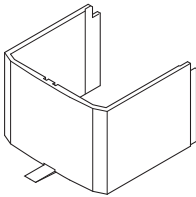
Part No.	Description
AW630 061	Detector assembly PCB 
AW630 051	LED assembly PCB – Color (blue) 
AW630 052	LED assembly PCB – Phosphate (infrared) 
AW630 053	LED assembly PCB – Manganese (blue) 



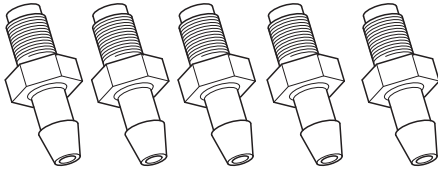
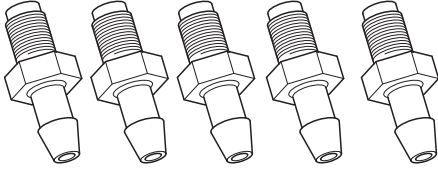

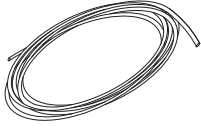

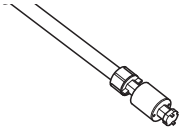
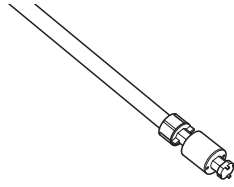
Part No.	Description
AW630 054 	LED assembly PCB – Manganese Low Range/Ammonia (red) 
AW630 055 	LED assembly PCB Aluminium/Iron – (amber) 
AW630 060 	Measurement head PCB 
AW630 099	LED/detector cover 

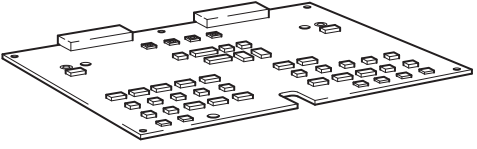

F.4.4 Plumbing and Tubing

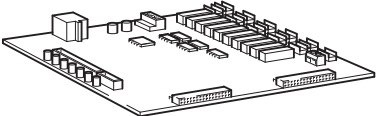
Part No.	Description
AW630 064	Pack of 5 replacement barbed fittings – M6 
AW630 094	Pack of 5 replacement barbed fittings – M5 
AW630 059	Analyzer tubing – Tygon R3603 $\frac{1}{16}$ in ID x $\frac{1}{32}$ in wall thickness – 15.24 m (50 ft) 
AW630 058	Analyzer tubing – Tygon 2075 Used on Manganese Low Range analyzer – 15.24 m (50 ft) 

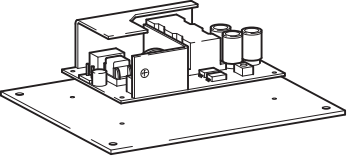
Part No.	Description
AW630 057	Level sensor assembly – 2.5 l / 5 l 
AW630 056	Level sensor assembly – 10 l 

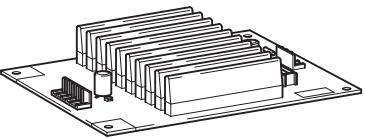
F.4.5 Electronic Boards

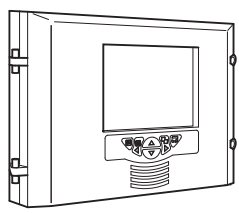
Part No.	Description
AW630 087	Interconnection PCB assembly
	
AW630 073	Applications PCB assembly
	
AW600 051	Aztec/Navigator PSU kit – AC
	
AW600 056	Aztec/Navigator PSU kit – DC
	

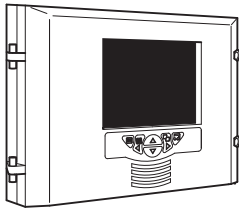
Part No.	Description
AW630 066	Front door assembly with membrane keypad (excluding display)
	
AW630 068	Front door assembly with membrane keypad plus display
	

F.5 Accessories

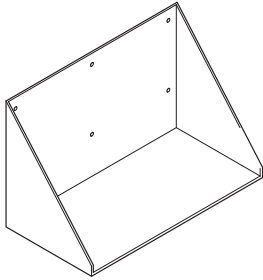
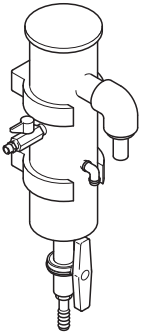
Part No.	Description
03-0051-A	Reagent support tray – stainless steel 
01-0107-A	Sample header pot 

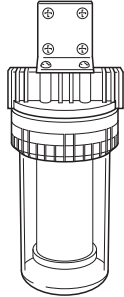
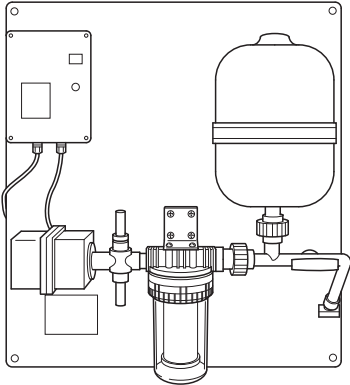
Part No.	Description
23-0022-A	EasyClean manual system – 25 micron 
90-0098-C	EasyClean automatic system – 25 micron 

Index

- A**
- Access
 - User access31
 - Alarm relays34
 - Alarms9
 - Fail safe35
 - New alarm9
 - Relay contact protection19
 - Analyzer configuration24
 - Analyzer diagnostic information56
 - Annotation
 - Chart49
 - Archive
 - Configuration38
 - File types44
 - Archiving
 - Data verification and integrity47, 48
- B**
- Brightness26
- C**
- Calibration
 - Date33
 - Fail event33
 - Frequency33
 - Time33
 - Cell rinse sequence32
 - Cell temperature32
 - Chart annotation49
 - Chart functions49
 - Chemical units32
 - Cleaning mode32
 - Clear non-volatile memory41
 - Commissioning41
 - Communications39
 - Configuration
 - Exiting configuration mode25
 - Internal switch protection28
 - Password protection28
 - Security
 - Internal switch28, 41
 - Type28
 - Connections
 - Cable connections16
 - Electrical connections15
 - Controls22
 - Current output test54
 - Current outputs36
- D**
- Date and time27
 - Daylight saving27, 47, 48, 49
 - Diagnostic information56
 - Dilution point41
 - Dimensions14
 - Display
 - Brightness26
 - Displays8
- E**
- Editing22
 - Email40
 - Ethernet39
- F**
- Fail safe35
 - File viewer44
 - Front panel controls22
- G**
- General operation85
 - Getting started10
 - Gradient coefficient33
- H**
- Historical review49
 - Hysteresis35
- I**
- Illustrated spares list95
 - Inactive user disabling30
 - Installation12
 - Location12
 - Instrument tag26
 - Instrument type41
 - Interference suppression19
- L**
- Language26
 - Logging
 - Configuration37
 - Logging of data42

M		S	
Maintenance	63	Sampling requirements	12
Changing reagents	63	Screen capture	26
Visual checks	64	Screen interval	50
Measurement rate	32	Screen saver wait time	26
Measuring units	32	SD card	43
Messages	31	Secure digital media	43
Operator	49	Security	28
Minimum password length	30	Security type	29
Mode of operation	41	Serial number	41
Monitor status	52	Software	
Mounting	13	Updating the software	94
		Spares	
N		Illustrated spares list	95
Navigation	22	Standards	
		High	33
O		Low	33
Operate	51	Statistics	55
Operator		Streams	32
Messages	49	Dilution ratio	32
Passwords	30	Number fitted	41
Security	30	Sequence	32
Optional accessories	12		
Outputs	36	T	
		Temperature control	86
P		Temperature units	32
Password expiry	30	Time	27
Password failure limit	30	Troubleshooting	79
Passwords	28, 31		
		U	
R		Updating the software	94
Ranges	37	User settings	31
Reagents	77		
Consumption of sample,		V	
standards and dilution water	78	Visual checks	64
Reconfigure preset	30		
Relay test	54	W	
Relays	34	Web server	90
Contact protection and interference suppression	19		

Contactos/Contacts:

Comercial/Commercial:

Fernando Mena Costa

e-mail: fcosta@bhb.pt

Tel: (+351) 21 843 64 00

Fax: (+351) 21 843 64 09

Assistência/Service:

Patricia Costa

e-mail: ppcosta@bhb.pt

Tel: (+351) 21 843 64 00



Note:

ABB the owner of this document, reserves the right to make technical changes or modify the contents of this document without prior notice. With regard to purchase orders, the agreed particulars shall prevail. ABB does not accept any responsibility whatsoever for potential errors or possible lack of information in this document.

Copyright© 2011

ABB. All rights reserved